

9000 64 086



ELEKTROVALVULA TIPO CAV 12V
9009049 =H8120 =080207 =73010

9005 64 086



ELEKTROVALVULA TIPO CAV 24V
7180049D DPC DPA = 080210

9014 64 086



ELEKTROVALVULA TIPO BOSCH 12V
0330001025 GOLF III

9032 64 086



VALVULA P/ AVANCO CAV C/2TERM
9108-153A

9119 64 086



ELEKTROVALVULA BOMBA DIESEL CAV
9108152A DPCN PSA

9905 64 086



VALVULA REG. LIQ. CHAUFAGE VAG
1K08200036D =0899350 711043400

47993 UN 086



VALVULA 4 VIAS VOLVO
3197585

☎ 253607320

9001 64 086



ELEKTROVALVULA TIPO CAV 24V
7180049

9006 64 086



ELEKTROVALVULA TIPO BOSCH 12V
033001015 =H8125 =73012

9015 64 086



ELEKTROVALVULA TIPO BOSCH 12V
330001028

9033 64 086



VALVULA P/ AVANCO CAV
9108-154B FIAT C/FICHA

9900 64 086



VALVULA REG. LIQ. CHAUFAGE FORD
CTMFR005 =24233+c =663007 OE

9909 64 086



VALVULA REG. LIQ. CHAUFAGE
1T0820036C/702256410 Q5/Q7

73010 56 086



ELEKTROVALVULA 12V
9943882 =9000 =H8120

✉ GERAL@VIEIRAFREITAS.PT

9003 64 086



ELEKTROVALVULA TIPO CAV 24V
7180049A = H8224

9007 64 086



ELEKTROVALVULA TIPO BOSCH 24V
0330001016 =080178 =73013

9030 64 086



VALVULA P/ CORTE DIESEL CAV
9109-262 DPC2 F.c/TERM

9052 64 086



ELEKTROVALVULA TIPO LUCAS 12V
9185-900G VAG =054500037

9901 64 086



VAL. REG. LIQ. CHAUFAGEM
BM5G8C605DA =0899288

9919 64 086



VALVULA REG. LIQ. REFRIG. MERCEDES
A2712030164 W204

73012 56 086



ELEKTROVALVULA VAG 12V
028130135B =9006 =080177 =H8125

🌐 VIEIRAFREITAS.PT

9004 64 086



ELEKTROVALVULA TIPO CAV 12V
7167620D DPC DPA = 080212

9008 64 086



VALVULA CORTE DIESEL DENSO
0960100500 =H8134

9031 64 086



VALVULA P/ AVANCO CAV
9108-147C RENAULT 2TERM= 080942

9053 64 086



VALVULA CORTE DIESEL 24V CAV
7185900H

9902 64 086



VALVULA REG. LIQ. CHAUFAGE
BM5G18495DA =CTMFR065

46452 86 086



VALVULA REG. LIQ. REFRIG. BMW
64118369805 E46 =0899083

73013 56 086



ELEKTROVALVULA 24V VAG
068130135B =9007 =080178

*atualizado 18/06/2026

73014 56 086



ELETROVALVULA 12V PRETA
11788580210 =3RG84107

080941 89 086



VALVULA P/ AVANCO CAV F.P
9108-153A FORD C/ 2 TERM = 9032

102654 TP 086



VALVULA REG. LIQ. REFRIG. VAG
171819809A =15920 =0899075

471024 03 086



VALVULA REG. LIQ. REFRIG. PSA
75515464

886022 41 086

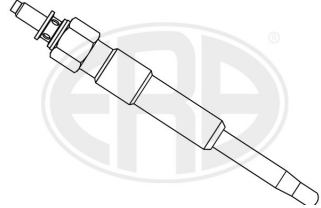

INFLAMADOR/VELA M4
596068 89mm

886226 41 086

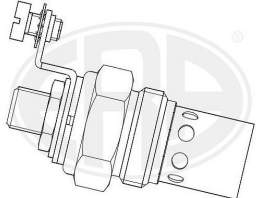

VELA INCANDESCENCIA 12V
1021910M91

0899080 10 086



VALVULA REG. LIQ. REFRIGERACAO
VAG = 4A0819809 VAG =111248

253607320

73018 56 086



ELETROVALVULA 12V MITSUBISHI
SPE0001/7W6249

080942 89 086



VALVULA P/ AVANCO CAV F.P
9108-147C RENAULT 2 Term. = 9031

109718 TP 086



VALVULA REG. LIQ. REFRIG. VAG
701819809D =CTMVW046

638777 TP 086



FLANGUE REG. LIQ. REFRIG. MERCED
6222000056 = 92857

886211 41 086



VELA INCANDESCENCIA 12V FORD
83956253 60mm ROSCA 20mm

886227 41 086

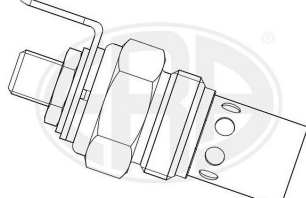

VELA/INFLAMADOR 24V PERKINS
2666104/CD10199

0899083 10 086



VALVULA REG. LIQ. REFRIG. BMW
64118369805 E46 =46452

GERAL@VIEIRAFREITAS.PT

080178 89 086



ELECTROVALVULA DIESEL BOSCH 24V
FALSE

081205 89 086



AQUECEDOR COMBUSTIVEL 12V
1455711005 FIAT/ALFA

111248 TP 086



VALVULA REG. LIQ. REFRIGERACAO
VAG =0899080 =4A0919809

638778 TP 086



FLANGE LIQ. REFRIGERACAO FIAT
6000616834 =4010344 =CTMRE047

886216 41 086

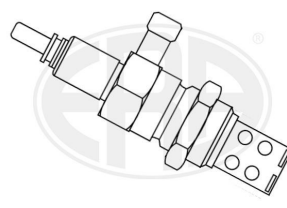

VELA AQUEC. MOTOR BOSCH
257201001

0899075 10 086



VALVULA REG. LIQ. REFRIG. VAG
171819809A =102654TP =15920

0899149 10 086



VALVULA REG. LIQ. REFRIG. VOLVO
36002684 S40/V40 =91594

VIEIRAFREITAS.PT

080940 89 086



VALVULA P/ AVANCO CAV F.P
9108-154B FIAT C/ FICHA = 9033

090278 89 086



RESISTENCIA ARRANQUE A FRIO PSA
Valv. relanti SEIM 083104 =FI2134

206241 TP 086



VALVULA REG. LIQ. REFRIG. OPEL
1820014 =9949 =0899077 =22001

663007 41 086



VALVULA REG LIQ CHAUFAGE FORD
1003929 FIESTA =9900+b

886222 41 086



INFLAMADOR/VELA 12V FIAT
4724601 5141702 ROSCA 22mm

0899077 10 086



VALVULA REG. LIQ. REFRIG. OPEL
1820014 =9949 =22001 =206241TP

0899288 10 086



VALVULA REG. LIQ. CHAUFAGEM FORD
BM5G8C605DA =9901

*atualizado 18/06/2026

0899350 10 086

metzger
AUTOTEILE



VALVULA REG. LIQ. CHAUFAGEM VAG
1K1820035C =9905 711043400

4010535 10 086

metzger
AUTOTEILE



VALVULA REG LIQ CHAUFAGE MERCEDE
A2722000054

H8220 20 086



VALVULA CORTE DIESEL BOSCH 24V
0330001016 =080178

H8407 20 086



VALVULA CORTE DIESEL LUCAS 24V
7180-49C

EV24V8MM UN 086



VALVULA CORTE COMBUSTIVEL 24V
8mm 0.7bar UNIVERSAL

886023 41 086

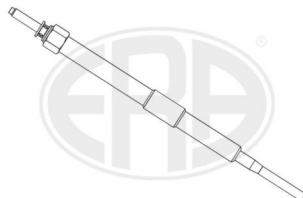

INFLAMADOR/VELA DENSO
DG240 =H1144

886079 41 086



VELA AQUEC. MOTOR DIESEL NISSAN
11065V7202 6.5V =CP71

☎ 253607320

4010307 10 086



VALVULA REG. LIQ. REFRIG. FORD
1371567 =9931 =CTMFR016

H8120 20 086



VALVULA P/CORTE DIESEL CAV
7167620B =9000 =73010

H8224 20 086



VALVULA CORTE DIESEL LUCAS 24V
7180-49A

H8410 20 086



VALVULA CORTE ARRANQUE MAN
51259020081/0210243124

EV24V12MM UN 086



VALVULA CORTE COMBUSTIVEL 24V
12mm 0.7bar

886037 41 086

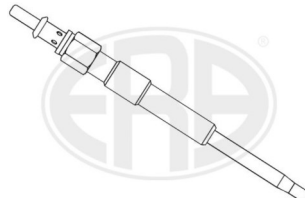

INFLAMADOR/VELA SMART
0004562V003 FORTWO H1658 =B114

886080 41 086

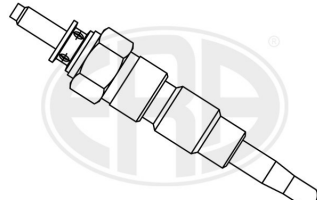

INFLAMADOR NISSAN
M87919 3.3TD 2.5D 2.2D

✉ GERAL@VIEIRAFREITAS.PT

4010342 10 086



VALVULA REG. LIQ. REFRIG. OPEL
95514688 MOVANO ###

H8125 20 086



ELECTROVALVULA DIESEL 12V
0960300070 =9006 =73012

H8228 20 086



VALVULA CORTE DIESEL DENSO 24V
0960300170 =080178

FI2134 AF 086



RESISTENCIA ARRANQUE A FRIO
164752 164762 = 090278

CTMFR016 85 086



VALVULA REG. LIQ. REFRIG. FORD
1371567 =9931 =4010307

886060 41 086



INFLAMADOR VAG
N10579805 =H5122

886081 41 086

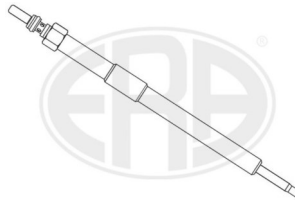

INFLAMADOR INFINITI
1106500Q0C Q70 =H5123

🌐 VIEIRAFREITAS.PT

4010344 10 086



FLANGE REG. LIQ. REFRIG. FIAT
6000616834 =638778TP =CTMRE047

H8134 20 086



VALVULA CORTE DIESEL DENDO
0960100500 =9008 =080680

H8305 20 086



VALVULA CORTE DIESEL 12V CAV
7167620D XD1203

EV12V8MM UN 086



VALVULA CORTE COMBUSTIVEL 12V
8mm 0.7bar UNIVERSAL

0250201027 BO 086



INFLAMADOR BOSCH
BMW OPEL ROVER =GV719

886077 41 086



INFLAMADOR PSA
5960E6 BERLINGO =H1368

886092 41 086



VELA AQUEC. MOTOR DIESEL NISSAN
11065V7203 6.5V =CP70 =H1576

886093 41 086

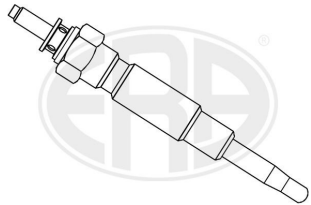

INFLAMADOR MITSUBISHI
3066657301

886103 41 086

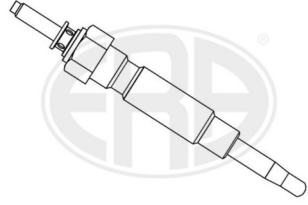

VELA AQUEC. MOTOR NISSAN
110654P400 =CP04

886106 41 086



INFLAMADOR MERCEDES
000159250167 =0250001016 =H0103

886112 41 086

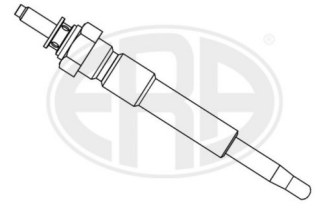

INFLAMADOR PSA
5962T3 1.5

886116 41 086

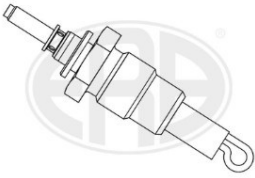

INFLAMADOR/VELA M5 MERCEDES
A1599001 0.9V

886119 41 086

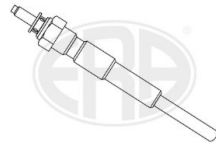

INFLAMADOR DAIHATSU/TOYOTA
198 505 601 074 177

886125 41 086

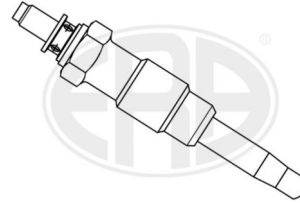

INFLAMADOR MERCEDES
11590401

886167 41 086

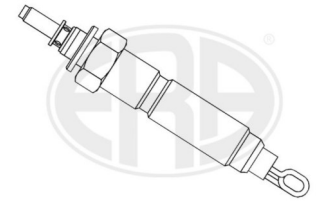

INFLAMADOR LAND ROVER
568335 DG131 CH45

886186 41 086



INFLAMADOR MERCEDES
A0011595601 W211 =H5209

886190 41 086



INFLAMADOR MASSEY FERGUSON
3704242M1

0250201034 BO 086



INFLAMADOR BOSCH
ALFA BMW VOLVO ETC =H1005

0250201042 BO 086



INFLAMADOR BOSCH
CITROEN FIAT PEUGEOT =H1086

0250201044 BO 086



INFLAMADOR BOSCH MERCEDES
0

0250201054 BO 086



INFLAMADOR BOSCH
MERCEDES = B082 =GN948 =H1087

0250202002 BO 086



INFLAMADOR BOSCH 11V
PSA HDI =H1821

0250202023 BO 086



INFLAMADOR BOSCH
ALFA FORD OPEL =GN007 =H1810

0250202025 BO 086



INFLAMADOR BOSCH
HONDA RENAULT =H1824 =GN905

0250202028 BO 086



INFLAMADOR BOSCH
ALFA JTD = B-108 =H1793

0250202043 BO 086



INFLAMADOR BOSCH
OPEL = B-107 =H1112

0250202085 BO 086



INFLAMADOR BOSCH 11V
OPEL/ISUZU = PI58 =H1692

0250202128 BO 086



INFLAMADOR BOSCH
RENAULT =B116 =GN026 =H1977

0250202129 BO 086



INFLAMADOR BOSCH
RENAULT =GN019 =B102 =H1922

0250202135 BO 086



INFLAMADOR BOSCH
FOCUS 06/03=> =B-131 =H1992

0250202140 BO 086



INFLAMADOR BOSCH
MERCEDES =H1738

0250204001 BO 086



INFLAMADOR BOSCH
PSA 1.4HDI FOCUS =GN047 =H1737

0250403002 BO 086



INFLAMADOR BOSCH
VAG 2.0TDi =GE101 =H1993=

0250403008 BO 086



INFLAMADOR BOSCH
MERCEDES W204 =H1122

0250403011 BO 086



INFLAMADOR BOSCH FIAT/OPEL/ALFA
4.4V =GE114 =H1396

0250603006 BO 086



INFLAMADOR BOSCH
12237803368 E81/F10 =H5210

H0903 20 086



INFLAMADOR/VELA HIDRIA IVECO
99473620 DAILY II

H1007 20 086



INFLAMADOR/VELA HIDIRA MERCEDES
0250201044/GV626/0001599101

H1087 20 086



INFLAMADOR/VELA HIDRIA MERCEDES
0011592001 B082/GN948/0250201054

H1091 20 086



INFLAMADOR/VELA HIDRIA OPEL
90464737 126mm 886114

H1112 20 086



INFLAMADOR/VELA HIDRIA OPEL
1214033 B107/GN033/0250202043

H1120 20 086



INFLAMADOR/VELA HIDRIA ROVER
ERR6066 B118/GN985

253607320

H0103 20 086



INFLAMADOR/VELA HIDRIA MERCEDES
0001592501 0250001016/886106

H1002 20 086



INFLAMADOR/VELA HIDRIA PSA/BMW
5962K5 GV636/0250201927 = H656

H1053 20 086



INFLAMADOR HIDRIA VAG/PSA VOLVO
GN857 N10213002 VW 5962J7

H1088 20 086



INFLAMADOR/VELA HIDRIA MERCEDES
0011591501 GN860/0250201035

H1096 20 086



INFLAMADOR/VELA HIDRIA FORD
1008792 B088/GN022/0250201049

H1113 20 086



INFLAMADOR/VELA RENAULT
U190034/CH248002 CLIOII/LOGAN

H1121 20 086



INFLAMADOR/VELA HIDRIA VAG
N10579201 0250202046 = H1810

GERAL@VIEIRAFREITAS.PT

H0584 20 086



INFLAMADOR/VELA HIDRIA IVECO
4832279 0257202004/886213/GF683

H1004 20 086



INFLAMADOR/VELA HIDRIA MERC. F.P.
0001598101/0250201001 =H1656

H1054 20 086



INFLAMADOR/VELA HIDRIA FIAT
60815294 =GN020

H1089 20 086



INFLAMADOR/VELA HIDRIA RENAULT
7700100586 GN999/0250202025

H1098 20 086



INFLAMADOR/VELA HIDRIA RENAULT
7700867617 GN959/0250201050

H1118 20 086



INFLAMADOR/VELA HIDRIA BMW
12237786869 GE102/0250402002

H1122 20 086



INFLAMADOR/VELA HIDRIA MERCEDES
0011595001 GE105/0250403008

VEIIRAFREITAS.PT

H0610 20 086



INFLAMADOR/VELA HIDRIA OPEL
1214303 GV137/0250200032

H1005 20 086



INFLAMADOR/VELA HIDRIA FIAT
60507123 GV657/0250201012

H1078 20 086



INFLAMADOR/VELA HIDRIA MERCEDES
0011590001 B078/GN858/0250201055

H1090 20 086



INFLAMADOR/VELA HIDRIA OPEL
1214457 GN992/0250202042

H1105 20 086



INFLAMADOR/VELA HIDRIA HYUNDAI
367104A000 B120/GN057/Y508J

H1119 20 086



INFLAMADOR/VELA HIDRIA BMW
1214018 B104/GN024/0250202103

H1124 20 086



INFLAMADOR/VELA HIDRIA
6641590001 B121/GN060/0250213007

*atualizado 18/06/2026

H1125 20 086



INFLAMADOR/VELA HIDRIA OPEL
94133759 PI49/GN061/0250202065

H1139 20 086



INFLAMADOR/VELA HIDRIA MERCEDES
A0011595201

H1159 20 086



INFLAMADOR/VELA HIDRIA RENAULT
7700105290 GN991/0250202024

H1200 20 086



INFLAMADOR/VELA HIDRIA VAG
062905061 149mm

H1207 20 086



INFLAMADOR/VELA HIDRIA CHRYSLER
05066840AA GN055/0250202038

H1211 20 086



INFLAMADOR/VELA HIDRIA HYUNDAI
3671042500 CP07/PM167/0250312007

H1369 20 086



INFLAMADOR/VELA HIDRIA PSA OE
5960L1 GE131/0250404002

253607320

H1126 20 086



INFLAMADOR/VELA HIDRIA OPEL
9111145 B072/GN927/0250202001

H1143 20 086



INFLAMADOR/VELA HIDRIA MERCEDES
0011592701 GN010/0250202041

H1166 20 086



INFLAMADOR/VELA HIDRIA PSA
596078 B123/GN056/0250204002

H1201 20 086



INFLAMADOR/VELA HIDRIA VAG OE
062905061A/ 0100226435/GN050

H1208 20 086



INFLAMADOR/VELA HIDRIA HYUNDAI
367102A100 134.5mm 887028

H1212 20 086



INFLAMADOR/VELA HIDRIA NISSAN
11065AD20A CP72/

H1391 20 086



INFLAMADOR/VELA HIDRIA NISSAN
110657F400 GN994/CP03

GERAL@VIEIRAFREITAS.PT

H1127 20 086



INFLAMADOR/VELA HIDRIA VAG
N10591602 GE100/0250402001

H1144 20 086



INFLAMADOR/VELA HIDRIA TOYOT/
GN042/0250202145 =886023

H1192 20 086



INFLAMADOR/VELA HIDRIA OPEL
1214028 VECTRA C

H1204 20 086



INFLAMADOR/VELA HIDRIA PN139
110657C000 GN039/0250202093

H1209 20 086



INFLAMADOR/VELA HIDRIA NISSAN
11065G5501 CP01/GN101/0250312001

H1339 20 086



INFLAMADOR/VELA HIDRIA VAG H1414
03L963319 GE108/GE115/0250403007

H1392 20 086



INFLAMADOR/VELA HIDRIA OE
GE110/0250403 =886034 =H1392M

VIEIRAFREITAS.PT

H1138 20 086



INFLAMADOR/VELA HIDRIA BMW
12237788957 E65/66

H1145 20 086



INFLAMADOR/VELA HIDRIA TOYOTA
PT157/GN065/0250202125

H1193 20 086



INFLAMADOR/VELA HIDRIA PSA
5960G6 C5 II

H1205 20 086



INFLAMADOR/VELA HIDRIA PN131
11065C8600 GN044/0250202064

H1210 20 086



INFLAMADOR/VELA HIDRIA NISSAN
1106557J00 CP02/GN102/0250312002

H1368 20 086



INFLAMADOR HIDRIA PSA OE
5960E6 =886077 GE121/025040401

H1393 20 086



INFLAMADOR/VELA HIDRIA RENAULT
8200794920 GE111/0250403013

*atualizado 18/06/2026

H1394 20 086



INFLAMADOR/VELA HIDRIA OPEL
55564219

H1395 20 086



INFLAMADOR/VELA HIDRIA HYUNDAI
367103A000 131mm

H1396 20 086



INFLAMADOR/VELA HIDRIA FIAT
55564162/GE114/0250403011

H1397 20 086



INFLAMADOR/VELA HIDRIA MERCEDES
A0011595101 130mm

H1398 20 086



INFLAMADOR/VELA HIDRIA JEEP
46072012F/0250402003

H1406 20 086



INFLAMADOR/VELA HIDRIA HONDA
12291RL0G01 CP53 =H5021

H1407 20 086



INFLAMADOR/VELA HIDRIA MAZDA
R2AA18601 886136/PZ712

H1408 20 086



INFLAMADOR/VELA HIDRIA CHRYSLER
68029497AA GE134/0250403004

H1410 20 086



INFLAMADOR/VELA HIDRIA MAZDA
RF8618601

H1411 20 086



INFLAMADOR HIDRIA SUBARU
22439AA000 GN116/PR801

H1418 20 086



INFLAMADOR/VELA HIDRIA MITSUB.
ME203539 PM168/GN070/0250202124

H1426 20 086



INFLAMADOR/VELA HIDRIA ROVER
ERR4084 GN926

H1430 20 086



INFLAMADOR/VELA TOYOTA
198500R020 PT500/GN108

H1436 20 086



INFLAMADOR/VELA HIDRIA HYUNDAI
367104X900 GN117 2.9CRDi

H1440 20 086



INFLAMADOR/VELA HIDRIA MITSUBISHI
ME193890

H1442 20 086



INFLAMADOR/VELA HIDRIA HYUNDAI
36710A700 0250523010

H1444 20 086



INFLAMADOR/VELA HIDRIA MITSUB.
1820A019 CP08/GN123/F01G004031

H1446 20 086



INFLAMADOR TOYOTA 166mm
1985030010 887057 600624TP

H1449 20 086



INFLAMADOR/VELA HIDRIA TOYOTA
1985067020 GN110/886095/CP22

H1451 20 086



INFLAMADOR/VELA HIDRIA TOYOTA
1985054130 886113/CP20

H1453 20 086



INFLAMADOR/VELA HIDRIA HYUNDAI
367102F100/GE130 2.0CRDi

H1458 20 086



INFLAMADOR/VELA HIDRIA VAG
N10302102 12V 886120

H1469 20 086



INFLAMADOR/VELA HIDRIA ISUZU
DG635 / GN095 / 0250213012

H1478 20 086



INFLAMADOR/VELA HIDRIA SUBARU
22439AA010/CP81 2.0D

H1532 20 086



INFLAMADOR/VELA HIDRIA MAZDA
PZ33/CH97/GV705/0250202007

H1547 20 086



INFLAMADOR/VELA HIDRIA MITSUB.
MD050212 PM75/GV673/0250202003

H1561 20 086



INFLAMADOR/VELA HIDRIA PN123
1106534W00 GV889/0250202014

H1568 20 086



INFLAMADOR/VELA HIDRIA PN128
11065T8200 GV892/025020201

H1576 20 086



INFLAMADOR/VELA HIDRIA NISSAN
11065V7203 =CP70 =886092

H1658 20 086



INFLAMADOR/VELA HIDRIA SMART
6601590001 FORTWO

H1691 20 086



INFLAMADOR/VELA HIDRIA OPEL
1214042 PI59/GV947/025020287

H1705 20 086



INFLAMADOR/VELA HIDRIA PSA/FORD
5960G2 B101/GN939/0250202130

H1732 20 086



INFLAMADOR/VELA HIDRIA PSA
96236383 B089/GN027/0250202032

H1780 20 086



INFLAMADOR/VELA PERKINS
2666A016 H5218

H1793 20 086



INFLAMADOR/VELA HIDRIA FIAT
46451951 95mm 886000

253607320

H1655 20 086



INFLAMADOR/VELA HIDRIA LOMBAR-
2 100 098 013 721 650

H1659 20 086



INFLAMADOR/VELA HIDRIA VAG
N10140101 b103/gn855/0250202022

H1692 20 086



INFLAMADOR/VELA HIDRIA OPEL
1214311 PI58/GV946/0250202085

H1709 20 086



INFLAMADOR/VELA HIDRIA OPEL
7700100558 B094/GN963/0250202035

H1737 20 086



INFLAMADOR/VELA HIDRIA PSA/FORD
1148105 B106/GN047/0250204001

H1784 20 086



INFLAMADOR/VELA HIDRIA KUBOTA
1685165512

H1794 20 086



INFLAMADOR/VELA HIDRIA FORD
1079401 =B105 =GN993 =0250202131

GERAL@VIEIRAFREITAS.PT

H1656 20 086



INFLAMADOR/VELA HIDRIA PSA/FORD
6154593 B081/GN954 GN909 =H1002

H1665 20 086



INFLAMADOR/VELA HIDRIA OPEL
5962T7 GV666/0250202018

H1693 20 086



INFLAMADOR/VELA HIDRIA PSA
59621P 118.5mm 886118

H1712 20 086



INFLAMADOR/VELA HIDRIA FIAT
46447610 B084/GN970/0250202034

H1739 20 086



INFLAMADOR/VELA HIDRIA MERCEDES
0011592801 B099/GN003/0250202141

H1789 20 086



INFLAMADOR/VELA FORD/KIA 4025139
CP60/GN005/0250202089 =PZ39

H1795 20 086



INFLAMADOR/VELA HIDRIA ROVER
ETC8847 B074/GV783/0250202040

VIEIRAFREITAS.PT

H1657 20 086



INFLAMADOR/VELA HIDRIA VAG
N0190971 B080/0250201032 =H1098

H1667 20 086



INFLAMADOR/VELA TOYOTA
PT155/GV968/0250202053

H1701 20 086



INFLAMADOR/VELA HIDRIA NISSAN
11065D9701 GV728

H1731 20 086



INFLAMADOR/VELA HIDRIA PSA
13721731 B087/GN016/0250202020

H1755 20 086



INFLAMADOR/VELA HIDRIA GN969
0250202097 =PT153 =ESZTY014

H1790 20 086



INFLAMADOR/VELA HIDRIA PT145 F.P
19 850 680 100 250 200 000

H1797 20 086



INFLAMADOR/VELA HIDRIA FORD
1952464 PN138/GN854/0250202093

H1798 20 086



INFLAMADOR/VELA HIDRIA PN126
1106516A05 GV685/0250202059

H1808 20 086



INFLAMADOR/VELA HIDRIA PSA
596072 76mm

H1821 20 086



INFLAMADOR/VELA HIDRIA PSA/FIAT
7632587 DG132/GV730/0250202002

H1859 20 086



INFLAMADOR/VELA HIDRIA OPEL
93178047 B122/GN053/0250203002

H1922 20 086



INFLAMADOR/VELA HIDRIA RENAULT
7700100635 B102/GN019/0250202129

H1977 20 086



INFLAMADOR/VELA HIDRIA OPEL
9201698 B116/GN026/0250202128

H5016 20 086



INFLAMADOR/VELA HIDRIA OPEL
55567737/GE117/0250403020

H1799 20 086



INFLAMADOR/VELA HIDRIA GV921
1106563G00 025020206 = PM166

H1810 20 086



INFLAMADOR/VELA HIDRIA FORD
1690048 B086/0250202023 = H1121

H1824 20 086



INFLAMADOR/VELA HIDRIA RENAULT
7700858208 B085/GN905/0250202025

H1860 20 086



INFLAMADOR/VELA HIDRIA OPEL
1214035 CP51/GN104/0250202137

H1944 20 086



INFLAMADOR/VELA HIDRIA PSA
596077 GN045/0250203004

H1992 20 086



INFLAMADOR/VELA HIDRIA PSA OE
596064 GN054/0250202135

H5017 20 086



INFLAMADOR/VELA HIDRIA NISSAN
1106500Q0H GE124/0250403021

H1801 20 086



INFLAMADOR/VELA HIDRIA PN132
1106510G00 GV920/0250202077

H1815 20 086



INFLAMADOR/VELA HIDRIA PSA OE
5960A3 PM403/GN037/F002G50048

H1826 20 086



INFLAMADOR/VELA HIDRIA PSA
5962X1 GV642

H1919 20 086



INFLAMADOR/VELA HIDRIA PT152
1985064030 GN043/0250202079

H1955 20 086



INFLAMADOR/VELA HIDRIA HYUNDAI
367102700 B110/GN035/0250212006

H1993 20 086



INFLAMADOR/VELA HIDRIA VAG
N10579802 GE101/0250403002

H5018 20 086



INFLAMADOR/VELA HIDRIA VOLVO
12640384 GE123/0250403001

H1802 20 086



INFLAMADOR/VELA HIDRIA OPEL
1214040 B109/GN041/0250202036

H1816 20 086



INFLAMADOR/VELA HIDRIA OPEL
13721816 B125/GN059/0250203001

H1842 20 086



INFLAMADOR/VELA HIDRIA FIAT
46751764 B119/GN030/0250201053

H1920 20 086



INFLAMADOR/VELA HIDRIA OPEL
1214043 CP50/GN103/0250312003

H1961 20 086



INFLAMADOR/VELA HIDRIA VAG
059963319 B111/GN008/0250202102

H5015 20 086



INFLAMADOR/VELA HIDRIA FORD
1717631 GE122/0250203018

H5020 20 086



INFLAMADOR/VELA HIDRIA CE803
1855079J50 GN097/0250202132

H5021 20 086

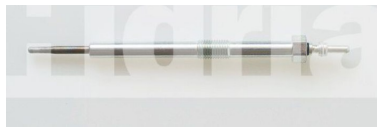

INFLAMADOR/VELA HIDRIA HONDA
12291RLOG01 =CP53 H1406

H5123 20 086



INFLAMADOR/VELA HIDRIA HYUNDAI
36710-2F000 ix35

H5150 20 086



INFLAMADOR/VELA PSA
5960E7 0250603005 3.0HDi

H5191 20 086



INFLAMADOR/VELA HIDRIA OPEL
96440144 GE125/0250403010

H5199 20 086



INFLAMADOR/VELA HIDRIA VAG
N10591604 CGP002/0250603021

H5221 20 086



INFLAMADOR/VELA HIDRIA MERCEDES
A0011597301 W176

H5240 20 086



INFLAMADOR / VELA HIDRIA OPEL
13725240 / GE1427/ 0250403019

253607320

H5025 20 086



INFLAMADOR/VELA HIDRIA PSA
5960L4 GE112/0250403014

H5124 20 086



INFLAMADOR/VELA HIDRIA MERCEDES
0011595701/CZ303

H5158 20 086



INFLAMADOR/VELA HIDRIA FIAT OE
55238404 OPEL 1.3CDTi 0250404004

H5192 20 086



INFLAMADOR/VELA HIDRIA OPEL
55570037/GE126/0250403023

H5209 20 086



INFLAMADOR HIDRIA MERCEDES
A0011595601 W211 =886186

H5222 20 086



INFLAMADOR/VELA HIDRIA MERCEDES
CZ159/A6421590101

H5247 20 086



INFLAMADOR/VELA HIDRIA MITSUBISHI
1820A009 PAJERO IV

GERAL@VIEIRAFREITAS.PT

H5093 20 086



INFLAMADOR/VELA HIDRIA MINI
12237798001/GE118/0250403018

H5126 20 086



INFLAMADOR HIDRIA CP75/CGP007
1106500Q0C =886081 0250603001

H5181 20 086



INFLAMADOR/VELA HIDRIA TOYOTA
13725181 AURIS

H5193 20 086



INFLAMADOR/VELA HIDRIA VAG
N10591607 GE119

H5210 20 086



INFLAMADOR HIDRIA BMW
12237803368 E81/F10/20

H5228 20 086



INFLAMADOR VELA RENAULT
929988247R 68MM =H1113

H5248 20 086



INFLAMADOR VELA/ HIDRIA FORD OE
PZ710 / 0250213008 / DG630

VIEIRAFREITAS.PT

H5122 20 086



INFLAMADOR HIDRIA VAG OE
N10579805 =886060/PM406

H5128 20 086



INFLAMADOR/VELA HIDRIA MAZDA
SH0118601 MAZDA 6 CP61

H5185 20 086



INFLAMADOR/VELA HIDRIA SMART
A6601590401 FORTWO

H5194 20 086



INFLAMADOR/VELA HIDRIA
A6711590101 2.0TDi GE120

H5213 20 086



INFLAMADOR/VELA HIDRIA VOLVO
32017066 0250603008

H5232 20 086



INFLAMADOR/VELA HIDRIA
6671590001 REXTON

H5254 20 086



INFLAMADOR/VELA HIDRIA PSA OE
9809088180 3008 1.5HDi H5166

*atualizado 18/06/2026 10

H5258 20 086



INFLAMADOR/VELA HIDRIA TOYOTA
1985011010 HILUX

H70011 20 086



INFLAMADOR/VELA HIDRIA VAG
03L905061M

PSG009 DA 086



VELA INFLAMADOR SENSOR VAG
12232361832

B 087 75 086



INFLAMADOR HKT CITROEN FIAT PEUG
0250202020 =GN016 =H1731

B 106 75 086



INFLAMADOR HKT PEUGEOT
PEUGEOT 206 HDI YE-04 =H1737

B 113 75 086



INFLAMADOR HKT PSA
59621P/1Q PSA2.5TDi H1693

CP 03 75 086



VELA AQUEC. MOTOR DIESEL HKT
NISSAN TERRANO CY-08 =H1391

253607320

H5262 20 086



INFLAMADOR/VELA HIDRIA OPEL
55512264 146mm

PSG004 DA 086



VELA INFLAMADOR OPEL
55568366 55568366 1214088 ASTRA

3RG 85504 RG 086



VALVULA REF. LIQ. RFRG. MERCEDES
A0018300784 124 T-MODEL 200 T

B 089 75 086



INFLAMADOR HKT PEUGEOT
0250202032 =GN027 =H1732

B 107 75 086



INFLAMADOR HKT OPEL
0250202043 =H1112

B 118 75 086



INFLAMADOR HKT ROVER
FREELANDER =H1120

CP 04 75 086



VELA AQUEC. MOTOR DIESEL HKT
110654P40A NISSAN =886103

GERAL@VIEIRAFREITAS.PT

H1392M 10 086



INFLAMADOR/VELA MOTRIO OE
8200682592 =H1392 =886034

PSG006 DA 086



INFLAMADOR VELA GM
55579436 1214087 CP5G006

B 080 75 086



INFLAMADOR HKT VW SEAT VOLVO
0250201032 =74141 =GN857 =H1657

B 104 75 086



INFLAMADOR HKT BMW
0250202103 =GN024 =H1119

B 108 75 086



INFLAMADOR HKT ALFA ROMEO
0250202028 H1793

B 119 75 086



INFLAMADOR HKT FIAT
46751764 FIAT 1.9D =H1842

CP 05 75 086



VELA AQUEC. MOTOR DIESEL HKT
PAJERO, CY-05

VIEIRAFREITAS.PT

H70001 20 086



INFLAMADOR/VELA HIDRIA VAG OE
04L905061B C/SENSOR

PSG007 DA 086



VELA INFLAMADOR SENSOR VAG
03L905061D 059905061H =H70011

B 081 75 086



INFLAMADOR HKT ALFA,BMW,PSA,REN.
0250201039/42 =GN954 =H1656

B 105 75 086



INFLAMADOR HKT FORD
TRUE

B 109 75 086



INFLAMADOR HKT JTD
0250202036 =GN041 = H1802

B 126 75 086



INFLAMADOR HKT KIA
KIA 1.5 CRDi II H1208

CP 07 75 086



VELA AQUEC. MOTOR DIESEL HKT
MD197511 =GN107 =H1211

*atualizado 18/06/2026



VELA AQUEC. MOTOR DIESEL HKT
WLE7-18-601 MAZDA



VELA AQUEC. MOTOR DIESEL HKT
CY-03 =GN103 =H1920

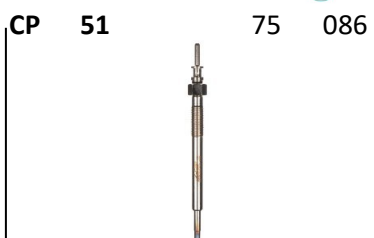

VELA AQUEC. MOTOR DIESEL HKT
CZ-22 OPEL ASTRA 1.7D =H1860

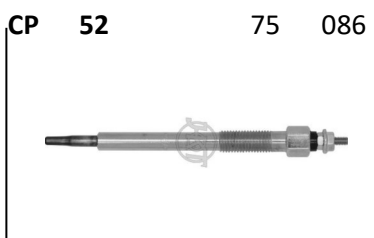

VELA AQUEC. MOTOR DIESEL HKT
OPEL/RENAULT H1192



VELA AQUEC. MOTOR DIESEL NISSAN
11065V7203 =H1576 =886092

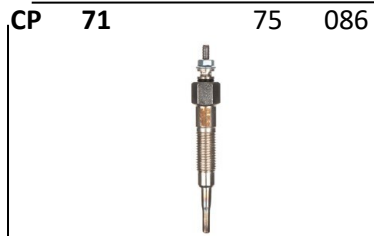

VELA AQUEC. MOTOR DIESEL NISSAN
11065V7202 =886079

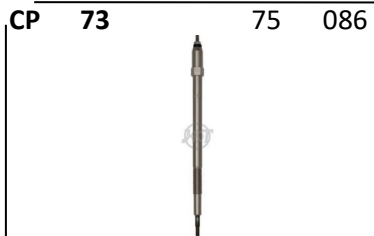

VELA AQUEC. MOTOR DIESEL HKT
NISSAN TERRANO CZ-21 H1432



VELA AQUEC. MOTOR DIESEL HKT
19850-33020 YARIS 1.4D-4D H5181



INFLAMADOR VELA OPEL C/SENSOR
55233532 1214057 ASTRA J



INFLAMADOR VELA OPEL C/SENSOR
55579436/1214101 =PSG006

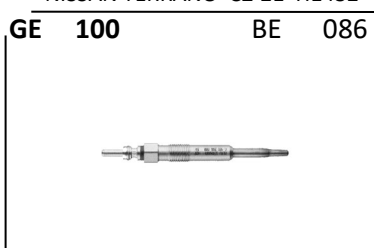

INFLAMADOR BERU N10591603
=0250402005 VAG 1.9TDi =H1127



INFLAMADOR BERU 1690048
=0250202023 FIAT/OPEL =H1810



INFLAMADOR BERU 059963319
=0250202102 VAG =H1961



INFLAMADOR BERU 5960F6
#REF!



INFLAMADOR BERU 7700100635
#REF!



INFLAMADOR BERU 60815294
71713981 =H1054



INFLAMADOR BERU 1056857
#REF!



INFLAMADOR BERU 1214080
=0250202128 OPEL =B116 =H1977



INFLAMADOR BERU 1214073
#REF!



INFLAMADOR BERU 5962J7
#REF!



INFLAMADOR BERU 0011591601
#REF!



INFLAMADOR BERU 7700867002
FALSE

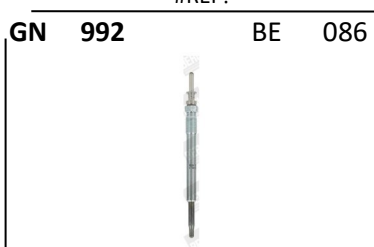

INFLAMADOR BERU 1214054
FALSE

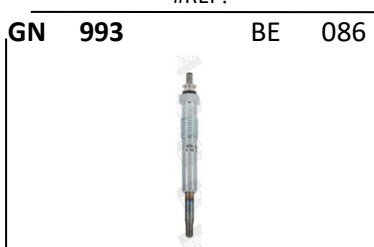

INFLAMADOR BERU 1079401
0250202131 =B105 =H1794



INFLAMADOR C.R.E.0250201017
11V = N68/SR68/SR70 =>sx68

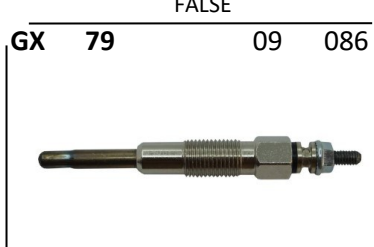

INFLAMADOR C.R.E.0100226354
GN012 Iveco Renault 2.8Tdi

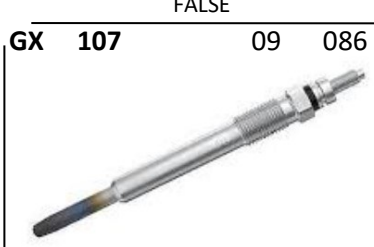

INFLAMADOR C.R.E.0250202032 PSA
GN027 0100226344 Citro Peug.HDI

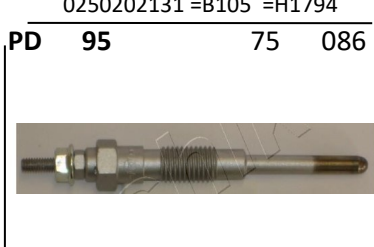

VELA AQUEC. MOTOR DIESEL HKT
067100-1100 8V

PH 10 75 086



VELA AQUEC. MOTOR DIESEL HKT
19120-1010A 0,95V

PI 42 75 086



VELA AQUEC. MOTOR DIESEL HKT
9-82511978-0 =100275 H0643

PI 45 75 086



VELA AQUEC. MOTOR DIESEL HKT
5-8140040-0 H1790

PI 46 75 086



VELA AQUEC. MOTOR DIESEL HKT
8-94221719-3 5V

PI 49 75 086



VELA AQUEC. MOTOR DIESEL HKT
8-94133-759-5, Y-904M =H1125

PI 50 75 086



VELA AQUEC. MOTOR DIESEL HKT
8-94135377-4 ISUZU NKR = GI 016

PI 57 75 086



VELA AQUEC. MOTOR DIESEL HKT
8.94481972.0, Y711RS

PI 58 75 086



VELA AQUEC. MOTOR DIESEL HKT
8-94319700-1 11V =H1692

PI 59 75 086



VELA AQUEC. MOTOR DIESEL HKT
8970440370/Y-719R =H1691

PI 175 75 086



VELA AQUEC. MOTOR DIESEL HKT
8980133920 ISUZU 3.0TDi H1469

PI 176 75 086



VELA AQUEC. MOTOR DIESEL HKT
8973265192 ISUZU 2.5TDi

PM 61 75 086



VELA AQUEC. MOTOR DIESEL HKT
ME967559 22,5V H5095

PM 73 75 086



VELA AQUEC. MOTOR DIESEL HKT
ME 017010 20,5V

PM 74 75 086



VELA AQUEC. MOTOR DIESEL HKT
ME 007547 20,5V

PM 75 75 086



VELA AQUEC. MOTOR DIESEL HKT
MD050212 12V =H1547

PM 79 75 086



VELA AQUEC. MOTOR DIESEL HKT
32A66-03100 UNIVERSAL HEAVY IND.

PM 164 75 086



VELA AQUEC. MOTOR DIESEL HKT
MD344460 MAZDA =317PHD

PM 165 75 086



VELA AQUEC. MOTOR DIESEL HKT
MITSUBISHI ME305950 H1412

PM 166 75 086



VELA AQUEC. MOTOR DIESEL HKT
HYUNDAI H100 =Y722J =H1799

PM 167 75 086



VELA AQUEC. MOTOR DIESEL HKT
Y-733 =GN107 =H1211

PM 169 75 086



VELA AQUEC. MOTOR DIESEL HKT
MITSUBISHI COLT 1.5Di-D =H1123

PM 401 75 086



VELA AQUEC. MOTOR DIESEL HKT
ME191813 CANTER

PM 402 75 086



VELA AQUEC. MOTOR DIESEL HKT
MITSUBISHI PICK-UP 2.5TD/3.2TD

PM 403 75 086



VELA AQUEC. MOTOR DIESEL HKT
MK667112 CANTER 3.0D =H1815

PM 405 75 086



VELA AQUEC. MOTOR DIESEL HKT
MN980234 MITSUBISHI 2.0Di-D

PN 81 75 086



VELA AQUEC. MOTOR DIESEL HKT
11065-37506 10,5V

PN 87 75 086



VELA AQUEC. MOTOR DIESEL HKT
11065-31W00/01 11V =H1561

PN 123 75 086



VELA AQUEC. MOTOR DIESEL HKT
11065-34W00 =H1561

PN 125 75 086



VELA AQUEC. MOTOR DIESEL HKT
11065-79000/1 23V

PN 131 75 086



VELA AQUEC. MOTOR DIESEL HKT
Y-755RS =H1205

PN 132 75 086



VELA AQUEC. MOTOR DIESEL HKT
11065-10G00 11V =H1801

PN 135 75 086



VELA AQUEC. MOTOR DIESEL HKT
11065-43G01 11V =H1799

PN 137 75 086



VELA AQUEC. MOTOR DIESEL HKT
11065-02T00 24V

PS 201 75 086



VELA AQUEC. MOTOR DIESEL HKT
15951-6551-2 UNIVERSAL INDUSTRIES

PS 202 75 086



VELA AQUEC. MOTOR DIESEL HKT
KUBOTA Y-106V 10,5V

PS 203 75 086



VELA AQUEC. MOTOR DIESEL HKT
18536-6060-Y107V 10.5V

PS 204 75 086



VELA AQUEC. MOTOR DIESEL HKT
KUBOTA Y-106-1 10,5V H5105

PS 206 75 086



VELA AQUEC. MOTOR DIESEL HKT
NGK YE-01 KUBOTA =H5019

PS 207 75 086



VELA AQUEC. MOTOR DIESEL HKT
16261-6551-1, 16241-6551-2

PS 209 75 086



VELA AQUEC. MOTOR DIESEL HKT
17331-6551-1, Y-119V, KUBOTA

PS 210 75 086



VELA AQUEC. MOTOR DIESEL HKT
129155-77801 = 100522

PS 217 75 086



VELA AQUEC. MOTOR DIESEL HKT
NGK Y182T-1 234466-31300

PS 219 75 086



VELA AQUEC. MOTOR DIESEL HKT
1752965511 12V KOBUTA

PS 221 75 086



VELA AQUEC. MOTOR DIESEL HKT
266-A012/013 PERKINS

PT 100 75 086



VELA AQUEC. MOTOR DIESEL HKT
19850-56021 8,5V

PT 101 75 086



VELA AQUEC. MOTOR DIESEL HKT
1985056012/886119/CH302/HDS238

PT 103 75 086



VELA AQUEC. MOTOR DIESEL HKT
19850-54030 11V

PT 104 75 086



VELA AQUEC. MOTOR DIESEL HKT
19850-68030 8,5V

PT 109 75 086



VELA AQUEC. MOTOR DIESEL HKT
19850-68040 20,5V = GT 207

PT 140 75 086



VELA AQUEC. MOTOR DIESEL HKT
19850-54050 7V H1605

PT 145 75 086



VELA AQUEC. MOTOR DIESEL HKT
19850-68010 10,5V =H1790

PT 150 75 086



VELA AQUEC. MOTOR DIESEL HKT
19850-64020, Y-703R

PT 152 75 086



VELA AQUEC. MOTOR DIESEL HKT
TOYOTA LAND CRUISER 11V =H1919

PT 153 75 086



VELA AQUEC. MOTOR DIESEL HKT 23V
19850-58010 =H1755 =ESZTY014

PT 155 75 086



VELA AQUEC. MOTOR DIESEL HKT
19850-54120 11V =H1667

PT 156 75 086



VELA AQUEC. MOTOR DIESEL HKT
19850-54150 HILUX II 2.4TD

PZ 30 75 086



VELA AQUEC. MOTOR DIESEL HKT
11065-T8200

PZ 31 75 086



VELA AQUEC. MOTOR DIESEL HKT
SE01-18140 23V

PZ 33 75 086



VELA AQUEC. MOTOR DIESEL HKT
S501-18140A 10,5V =H1532

PZ 36 75 086



VELA AQUEC. MOTOR DIESEL HKT
VS01-18-601

PZ 38 75 086



VELA AQUEC. MOTOR DIESEL HKT
KYA

PZ 39 75 086



VELA AQUEC. MOTOR DIESEL HKT
WL0318601Y701V 11V =H1789

PZ 702 75 086



VELA AQUEC. MOTOR DIESEL HKT
RFP1-18-601 MAZDA

PZ 703 75 086



VELA AQUEC. MOTOR DIESEL HKT
IE07-18-601 FORD/MAZDA 1.8TD

PZ 704 75 086



VELA AQUEC. MOTOR DIESEL HKT
RF2A-18-601 MAZDA H1215