

:Catálogo

SERTRONIC

2025

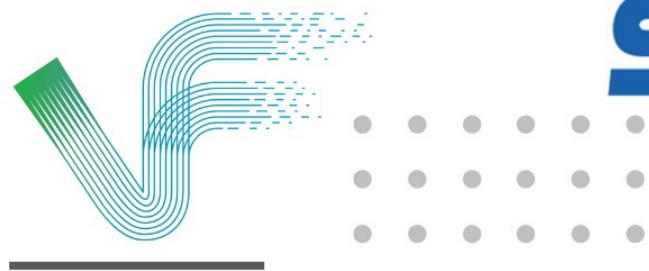

VIEIRA & FREITAS LDA.

CDC1019NG 29 001



FITA ADESIVA DUPLA FACE
10x19mm

CTA2519NG 29 001



FITA ADESIVA ALGODAO 10m
PRETA

CTP2519NG 29 001



FITA ADESIVA POLIESTER 25m
PRETA

HC1011 29 001



BASE ABRACADEIRA AUTO COLANTE
3.6mm

N25100 29 001



ABRACADEIRA NYLON 2.5x100
=02150 =BR10025N =TK25100

N25120 29 001



ABRACADEIRA NYLON 2.5x120
=02151 150x2.5

N25203 29 001



ABRACADEIRA NYLON 2.5x200
=4621430 =02152 =BR20025N

N32140 29 001



ABRACADEIRA NYLON 3.6x140
=4621440 =BR14235N

N36292 29 001



ABRACADEIRA NYLON 3.6x300
=TK36300 =BR29236N 290mm

N46203 29 001



ABRACADEIRA NYLON 4.8x200
=4621480 =02155 =BR20048N

N48190 29 001



ABRACADEIRA NYLON 4.8x188
=4621470 188mm

N50250 29 001



ABRACADEIRA NYLON 4.8x250
=4621490 =BR25048N

N50280 29 001



ABRACADEIRA NYLON 4.8x280

N50310 29 001



ABRACADEIRA NYLON 4.8x300
=02156 =TK48300

N50368 29 001



ABRACADEIRA NYLON 4.8x370
=BR36850N 360mm

N79380 29 001



ABRACADEIRA NYLON 7.8x380
=BR430900 450mm

N80450 29 001



ABRACADEIRA NYLON 9x450

N90762 29 001



ABRACADEIRA NYLON 9x775
=46.21590

R00400 29 001



BLISTER BARRA LIGADORES 4mm
10x12unidades =E100N

R00600 29 001



BLISTER BARRA LIGADORES 6mm
10x12unidades =E110N

R01000 29 001



BLISTER BARRA LIGADORES 10mm
10x12UNIDADES =E120N

R01600 29 001



BLISTER BARRA LIGADORES 16mm
10x12unidades =E130N

SE1019AM 29 001



FITA ADESIVA PVC 10 METROS
AMARELA

SE2019NG 29 001



FITA ISOLADORA PVC PRETA
=4640200 =101DENKA =RC201915

SE3319NG 29 001



FITA ADESIVA PRETA 10m
10m - 19mm

CI075AZ 29 015



FIO INSTALACAO - Azul - 0,75mm
Rolo 100m =04AZ

CI075NG 29 015



FIO INSTALACAO 0,75mm PRETO
ROLO 100m =04NG =CI075N =R4NG

CI075RO 29 015



FIO INSTALACAO VERMELHO 0,75mm
ROLO 100m =04RJ =CI075R =R4RJ

CI10NG 29 015



CABO BATERIA - 10mm - Preto
Rolo 50m

CI15AZ 29 015



FIO INSTALACAO 1.5mm AZUL
ROLO 100m =06AZ =CI150AZ =R6AZ

CI15BL 29 015



FIO INSTALACAO - Branco - 1.5mm
Rolo 100m = 06BC

CI15NG 29 015



FIO INSTALACAO 1.5mm PRETO
ROLO 100m =06NG =CI150N =R6NG

CI15RO 29 015



FIO INSTALACAO VERMELHO 1.5mm
ROLO 100m =06RJ =CI150R

CI16NG 29 015



CABO BATERIA - 16mm - Preto
Rolo 25m = AN16 =F616

CI1AZ 29 015



FIO INSTALACAO AZUL 1mm
ROLO 100m =05AZ =CI100AZ =R5AZ

CI1BL 29 015



FIO INSTALACAO 1mm BRANCO
ROLO 100m =05BC =R5BC

CI1MA 29 015



FIO INSTALACAO CASTANHO 1mm
ROLO 100m =05MR =CI100M =R5MR

CI1NG 29 015



FIO INSTALACAO PRETO 1mm
ROLO 100m =05NG =CI100N

CI1RO 29 015



FIO INSTALACAO VERMELHO 1mm
ROLO 100m =05RJ =CI100R

CI25NG 29 015



FIO INSTALACAO PRETO 2.5mm
ROLO 100m =08NG =CI250N

CI25RO 29 015



FIO INSTALACAO VERMELHO 2.5mm
ROLO 100m =08RJ =CI250R

CI35N 29 015



CABO BATERIA PRETO 35mm
VENDA METRO =AN35 =CISR35=F635

CI35R 29 015



CABO BATERIA 35mm VERMELHO
ROLO 25m =AR35 =CISR35R =F735

CI50N 29 015



CABO BATERIA 50mm PRETO
ROLO 25m =AN50 =F650

CIM2 29 015



CABO ATRELADO - 2x1.00mm
ROLO 50m = 21CM

CIM4 29 015

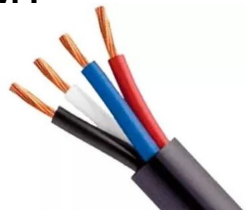

CABO ATRELADO 4x1mm
ROLO 50m =41CM =CMG41

CIP050RN 29 015



FIO INSTALACAO DUPLO - 2x0.50mm
ROLO 100m VERMELHO/PRETO =

CIP075RN 29 015



FIO INSTALACAO DUPLO 2x0.75mm
VERM/PRETO 100m =22RN

CIP1RN 29 015



FIO INSTALACAO DUPLO 2x1mm
VERM/PRETO 100m =23RN =CP21RN

CM2 29 015



CABO ENTRELACADO DE MASSA
15mm =2508663

CM24 29 015



CABO ENTRELACADO DE MASSA
25mm

CM4 29 015



CABO ENTRELACADO DE MASSA
25mm =2508662

CM5 29 015



CABO ENTRELACADO DE MASSA
15mm =2508660

CM7 29 015



CABO ENTRELACADO DE MASSA
15mm =2508661

LT127 29 015



TUBO RETRATIL 12.7x6.4mm
1 METRO

LT190 29 015



TUBO RETRATIL 19x9mm
1 METRO =193009



TUBO RETRATIL 3.2x1.75mm
1 METRO =193004



TUBO RETRATIL 4.8x2mm
1 METRO =193172 C/10m =LT48



TUBO RETRATIL 6.4x3.5MM
1 METRO =193006



TUBO RETRATIL 9.5x5mm
1 METRO =193007

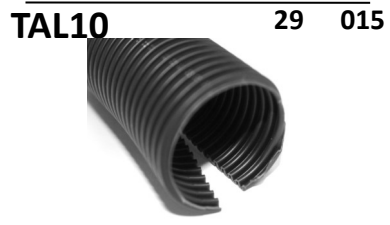

TUBO CANELADO ABERTO
ROLO 50m

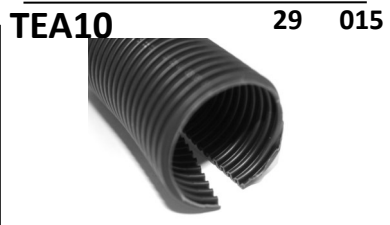

TUBO CANELADO FLEXIVEL
ROLO 50m =194681 =CA16R

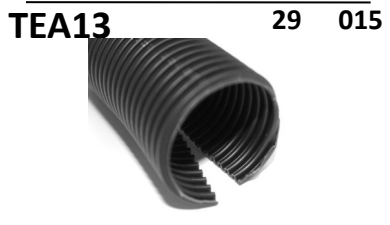

TUBO CANELADO FLEXIVEL
ROLO 50m =191946

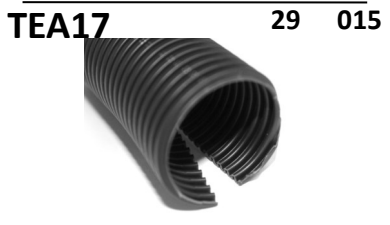

TUBO CANELADOR 16,8x21m
ROLO 50m =191947 =194683

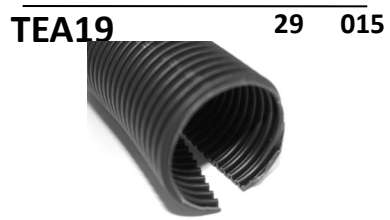

TUBO CANELADO FLEXIVEL
ROLO 50m =194684

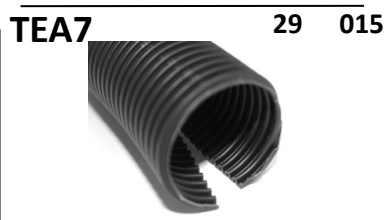

TUBO CANELADO FLEXIVEL
ROLO 50m =194680 =CA11R



ESCOVA LIMPA VIDROS SILENCE 350
=160635



ESCOVA LIMPA VIDROS SILENCE 400
=160641



ESCOVA LIMPA VIDROS SILENCE 450
=160645



ESCOVA LIMPA VIDROS SILENCE 480
=160648



ESCOVA LIMPA VIDROS SILENCE 500
=160650



ESCOVA LIMPA VIDROS SILENCE 530
=160653



ESCOVA LIMPA VIDROS SILENCE 550
20%?_ =160655



ESCOVA L/V 41CM X2

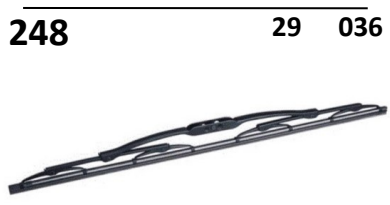

JOGO ESCOVA L/V 48cm

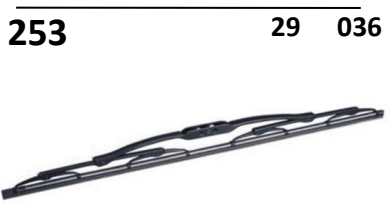

JOGO ESCOVAS L/V 53cm



FICHA LIG. P/INJETOR
2VIAS(terminal 191551) =81108



FICHA LIG. P/INJETOR
2VIAS



FICHA LIG. P/INJETOR
2VIAS (term.192155) =81109



FICHA LIG. P/INJETOR 3 VIAS
FEMEA=192148=81114 2821911



FICHA ISOLADA LIG. MACHO S-SEAL
2P =3050125 =192080

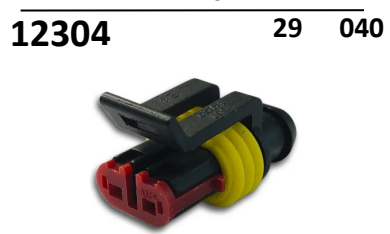

FICHA ISOLADA LIG. FEMEA S-SEAL
2P =3050126 =192079



FICHA ISOLADA LIG. MACHO S-SEAL
3P =3050127 =192082



FICHA ISOLADA LIG. FEMEA S-SEAL
3P =3050128 =192081

12307 29 040



FICHA LIG. MACHO S-SEAL
4P ISOLADA =3050129 =192084

12308 29 040



FICHA ISOLADA LIG. FEMEA S-SEAL
4P =3050130 =192083

12309 29 040



FICHA ISOLADA LIG. MACHO S-SEAL
5P =3050131 =192086

12310 29 040



FICHA ISOLADA LIG. MACHO S-SEAL
6V =3050133 =192088

12311 29 040



FICHA ISOLADA LIG. FEMEA S-SEAL
5P =3050132 =192085

12312 29 040



FICHA ISOLADA LIG. FEMEA S-SEAL
6V =3050134 =192087

21600002 29 040



PORTA RELE 3/4/5 PINOS
MICRO-RELE + TERMINAL

21600003 29 040



PORTA RELAIS UNIVERSAL
=4410245 =CPH505

21600004 29 040



PORTA RELES 9 VIAS
=190766 = 192158

9001 29 040



FICHA PLAST. FEMEA P/TERMINAIS
2P =190272 =4410200 =CPH202

9002 29 040



FICHA PLASTICA MACHO P/TERMINAIS
2P =190843 =4410190 =CPM202

9003 29 040



FICHA P/TERMINAIS MACHO
=4410160

9004 29 040



FICHA PLAST. FEMEA P/TERMINAIS
=4410150

9005 29 040



FICHA PLASTICA FEMEA P/TERMINAIS
BRANCO 2P =190261 =4410180 =CPH200

9006 29 040



FICHA PLASTICA P/TERMINAIS
BRANCO =190260 =4410170 =CPM200

9007 29 040



FICHA PLASTICA FEMEA P/TERMINAIS
3P =190263 =4410220 =CPH300

9008 29 040



FICHA PLASTICA MACHO P/TERMINAIS
3P =190262 =4410210 =CPM300

9010 29 040



FICHA PLASTICA FEMEA P/TERMINAIS
BRANCO 4P =190265 =4410240

9011 29 040



FICHA PLASTICA MACHO P/TERMINAIS
BRANCO 4P =190264 =4410230

9012 29 040



FICHA PLAST. FEMEA P/TERMINAIS
6P =4410260 =190267 =CPH600

9013 29 040



FICHA PLAST. F/M P/TERMINAIS
6P =4410250 =190266 =CPM600

9014 29 040



FICHA PLAST. FEMEA P/ 6 VIAS

9015 29 040



FICHA PLAST. MACHO P/ 6 VIAS

9016 29 040



FICHA PLAST. FEMEA P/TERMINAIS
8P =4410280 =190269 =CPH800

9017 29 040



FICHA PLAST. F/M P/TERMINAIS
8P =4410270 =190268 =CPM800

9202 29 040



FICHA PLAST. FEMEA P/TERMINAIS
11P =4410296

9203 29 040



FICHA PLAST. MACHO P/TERMINAIS
11P =4410295

03.00152 29 046



FUSIVEL TIPO BOSCH 10A
TORPEDO =20503010

03.00300 29 046

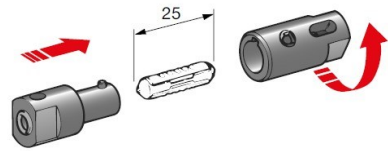

PORTA FUSIVEIS TIPO BOSCH 8A
=21502001

20210030 29 046



FUSIVEL MIDIVAL 30A LARANJA
=192427 =0602030 =FU5630 =03473

20210040 29 046

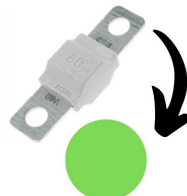

FUSIVEL MIDIVAL 40A VERDE
=192428 =0602040 =FU5640 =03474

20210050 29 046

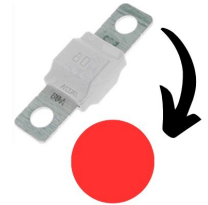

FUSIVEL MIDIVAL 50A VERMELHO
=192429 =03475 =FU5650

20210060 29 046

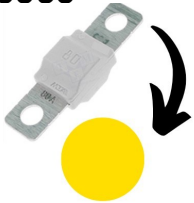

FUSIVEL MIDIVAL 60A AMARELO
=192430 =FU5660 =03476

20210070 29 046

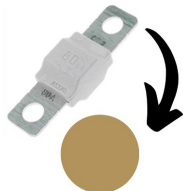

FUSIVEL MIDIVAL 70A CASTANHO
=03477=192431 =FU5670

20210080 29 046



FUSIVEL MIDIVAL 80A BRANCO
=192432 =FU5680 =03478

20210100 29 046

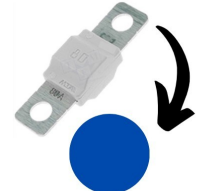

FUSIVEL MIDIVAL 100A AZUL=192433
=0602100 =FU60100 =03479

20210125 29 046

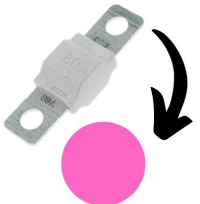

FUSIVEL MIDIVAL 125A ROSA
=0602125 =192434 =03480

20211050 29 046



FUSIVEL MIDIVAL 50A
32V PRETO/CINZA

20211150 29 046

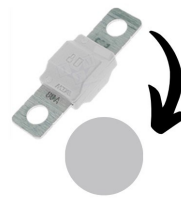

FUSIVEL MIDIVAL 150A
=192435 0608150 =03481

20211175 29 046

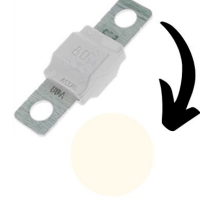

FUSIVEL MIDIVAL 175A
=0608175

20211200 29 046

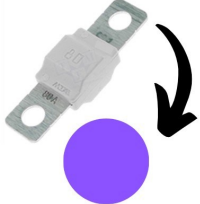

FUSIVEL MIDIVAL 200A ROXO
=192976 =193318 =03482

20212030 29 046



FUSIVEL HSB 30A
=192798 =03497

20212040 29 046



FUSIVEL HSB 40A
=192799 =03498

20212050 29 046



FUSIVEL HSB 50A
=192800 =03499

20212060 29 046



FUSIVEL HSB 60A
=192801 =03500

20212080 29 046



FUSIVEL HSB 80A
=192802 =03501

20212150 29 046



FUSIVEL HSB 150A
N10424906 =192804 =03504

20212175 29 046



FUSIVEL HSB 175A
=192805 =03505

20214050 29 046



FUSIVEL TIPO BOSCH CHAPA 50A
=0200297 =FU2050 =03491

20214080 29 046



FUSIVEL TIPO BOSCH CHAPA 80A
=0200298 =FU2080 =03493

20214100 29 046



FUSIVEL TIPO BOSCH 100A
=0200299 =03494

20222100 29 046



FUSIVEL MEGAVAL 100A AMARELO
=0601100 =192049 =FU61100

20222125 29 046

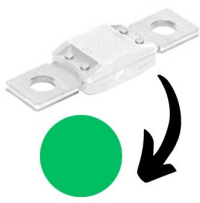

FUSIVEL MEGAVAL 125A VERDE
=0601125 =192050 =FU61125

20222150 29 046



FUSIVEL MEGAVAL 150A VERMELHO
=192051 =0601150 =FU61150

20222175 29 046

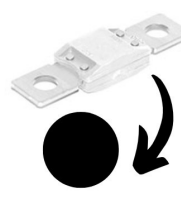

FUSIVEL MEGAVAL 175A PRETO
=192052 =FU61175 =03466

20222200 29 046

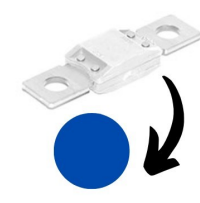

FUSIVEL MEGAVAL 200A AZUL
=192053 =03467 =FU61200

20222225 29 046

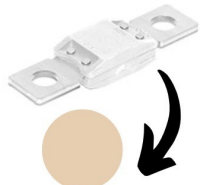

FUSIVEL MEGAVAL 225A
=03468

20222250 29 046



FUSIVEL MEGAVAL 250A ROSA
=192230 =FU61250 =03469

20222300 29 046



FUSIVEL 300A CINZENTO
=0601300 =192231 =03470

20222400 29 046

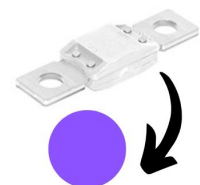

FUSIVEL MEGAVAL 400A VIOLETA
=03471 =192978

20222500 29 046



FUSIVEL MEGAVAL 500A CASTANHO
=193308 =0601600 =03472

20225250 29 046



FUSIVEL BATERIA 12/80V 250A
=192332

20225300 29 046



FUSIVEL 300A

20225355 29 046



FUSIVEL BATERIA 12/80V 355A
=192335

20226003 29 046



FUSIVEL POWERVAL VERMELHO
CAL. 3 =0601450

20231020 29 046



FUSIVEL JAPVAL FEMEA 20A AZUL
=0470020 =191638 =03388

20231030 29 046



FUSIVEL JAPVAL FEMEA 30A ROSA
=0470030 =191152 =FU5530 =03389

20231040 29 046



FUSIVEL JAPVAL FEMEA 40A VERDE
=0470040 =191153 =03390

20231050 29 046



FUSIVEL JAPVAL FEMEA 50A VERM.
=0470050 =191970 =FU5550 =03391

20231060 29 046



FUSIVEL JAPVAL FEMEA 60A =191154
=FU5560 =03392

20231070 29 046



FUSIVEL JAPVAL FEMEA 70A
=03393

20231080 29 046



FUSIVEL JAPVAL FEMEA 80A PRETO
=0470080 =FU5580 =03394

20231100 29 046



FUSIVEL JAPVAL FEMEA 100A AZUL
=0470100 =FU55100 =03395

20233070 29 046



FUSIVEL JAPVAL FEMEA 70A LOW P.
16x10mm CASTANHO

20233080 29 046



FUSIVEL JAPVAL FEMEA 80A PRETO
16x10mm LOW PROFILE

20233100 29 046

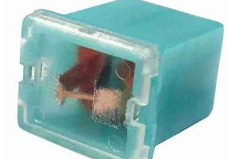

FUSIVEL JAPVAL FEMEA 100A AZUL
16x10mm LOW PROFILE

20233920 29 046



FUSIVEL LOW PROFILE 20A
=192779 =03451

20233925 29 046



FUSIVEL LOW PROFILE 25A
=192780 =03452

20233930 29 046



FUSIVEL LOW PROFILE 30A
=192781 =03453

20233940 29 046



FUSIVEL LOW PROFILE 40A
=192782 =03454

20233950 29 046



FUSIVEL LOW PROFILE 50A
=192783 =03455

20233960 29 046



FUSIVEL LOW PROFILE 60A
=192784 =03456

20234915 29 046



FUSIVEL MICRO JAP FEMEA 15A
17.5x10.7mm CINZENTO

20234920 29 046



FUSIVEL MICRO JAP FEMEA 20A
17.5x10.7mm AZUL

20234925 29 046



FUSIVEL MICRO JAP FEMEA 25A
17.5x10.7mm BRANCO

20234930 29 046



FUSIVEL MICRO JAP FEMEA 30A
17.5x10.7mm ROSA

20234940 29 046



FUSIVEL MICRO JAP FEMEA 40A
17.5x10.7mm VERDE

20235020 29 046



FUSIVEL JAPVAL FEMEA 20A AZUL
=0474020 =03443

20235030 29 046



FUSIVEL JAPVAL FEMEA 30A ROSA
=0474030 =191672 =03444

20235040 29 046



FUSIVEL JAPVAL FEMEA 40A VERDE
=0474040 =191673 =FU7440=03445

20235050 29 046



FUSIVEL JAPVAL FEMEA 50A VERM.
=0474050 =03446

20235060 29 046



FUSIVEL JAPVAL FEMEA 60A AMARELO
=0474060 =FU7460 =03447

20235070 29 046



FUSIVEL JAPVAL FEMEA 70A CASTA.
=0474070 =03448

20235080 29 046



FUSIVEL JAPVAL FEMEA 80A PRETO
=0474080 =03449

20235100 29 046



FUSIVEL MINI JAP 100A
=03450

20237925 29 046



FUSIVEL JAPVAL MINI CLIP 25A
CASTANHO =03412 =191830

20237930 29 046



FUSIVEL JAPVAL MINI CLIP 30A
VERDE =191831 =03413

20239020 29 046



FUSIVEL JAPVAL FEMEA 20A AZUL

20239030 29 046



FUSIVEL JAPVAL FEMEA 30A ROSA

20239040 29 046



FUSIVEL JAPVAL FEMEA 40A VERDE

20239050 29 046



FUSIVEL JAPVAL FEMEA 50A
VERMELHO

20239060 29 046



FUSIVEL JAPVAL FEMEA 60A
AMARELO

20239070 29 046



FUSIVEL JAPVAL FEMEA 70A
CASTANHO

20239080 29 046



FUSIVEL JAPVAL FEMEA 80A PRETO

20239100 29 046



FUSIVEL JAPVAL FEMEA 100A AZUL

20241060 29 046



FUSIVEL JAPVAL MACHO 60A AMARELO
=0475060 =191636 =03421

20241080 29 046



FUSIVEL JAPVAL MACHO 80A PRETO
=03423

20241100 29 046



FUSIVEL JAPVAL MACHO 100A AZUL
=0475100

20242020 29 046



FUSIVEL JAPVAL MACHO 20A

20242030 29 046

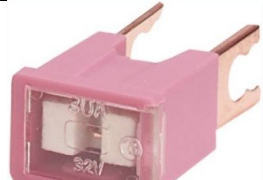

FUSIVEL JAPVAL MACHO 30A ROSA
=0471030 =191155 =FU6030 =03397

20242040 29 046



FUSIVEL JAPVAL MACHO 40A VERDE
=0471040 =191973 =FU6040

20242050 29 046

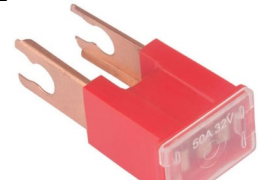

FUSIVEL JAPVAL MACHO 50A VERM.
=0471050 =191974 =FU6050 =03408

20242060 29 046



FUSIVEL JAPVAL FEMEA 60A =191154 =03409

20242070 29 046



FUSIVEL JAPVAL MACHO 70A

20242080 29 046



FUSIVEL JAPVAL MACHO 80A PRETO =191157 =FU6080 =03402 =03410

20242100 29 046



FUSIVEL JAPVAL MACHO 100A AZUL =0471100 =191971 =03403 =03411

20243020 29 046



FUSIVEL JAPVAL LATERAL 20A AZUL =0472030 =191628

20243030 29 046

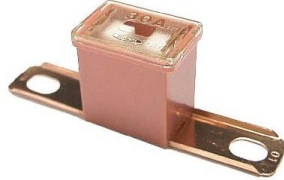

FUSIVEL JAPVAL LATERAL 30A ROSA =0472030 =191628 =FU6530 =03427

20243040 29 046



FUSIVEL JAPVAL LATERAL 40A VERDE =0472040 =191629 =FU6540 =03428

20243050 29 046

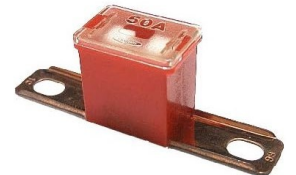

FUSIVEL JAPVAL LATERAL 50A

20243060 29 046



FUSIVEL JAPVAL LATERAL 60A AMAR. =0472060 =191631 =FU6560 =03429

20243070 29 046

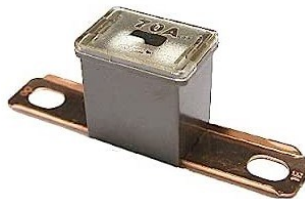

FUSIVEL JAPVAL LATERAL 70A

20243080 29 046



FUSIVEL JAPVAL LATERAL 80A PRETO =0472080 =191972 =FU6580 =03432

20243100 29 046

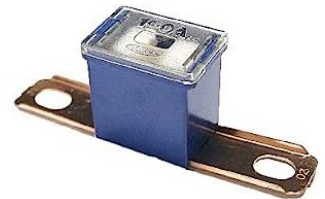

FUSIVEL JAPVAL LATERAL 100A AZUL =0472100 =191977 =FU65100 =03433

20256101 29 046



FUSIVEL UNIVERSAL DIODO 1A C/CONECTOR 90 GRAUS

20256111 29 046



FUSIVEL UNIVERSAL DIODO 1A 10x20mm

20256112 29 046



FUSIVEL UNIVERSAL DIODO 2A 19x20mm

20260020 29 046



FUSIVEL FICHA MAXI 20A AMARELO =0600900 =191249 =02324 =03381

20260025 29 046



FUSIVEL FICHA MAXI 25A

20260030 29 046



FUSIVEL FICHA MAXI 30A =03382 =0600910 =191250 =FU5030 =02325

20260035 29 046



FUSIVEL FICHA MAXI 35A

20260040 29 046

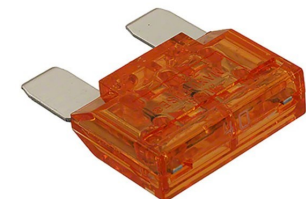

FUSIVEL FICHA MAXI 40A =03383 =0600920 =191251 =FU5040 =02326

20260050 29 046



FUSIVEL FICHA MAXI 50A VERMELHO =0600930 =191252 =FU5050 =02327

20260060 29 046

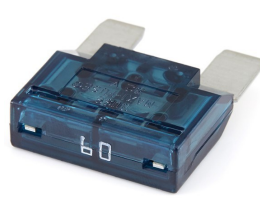

FUSIVEL FICHA MAXI 60A AZUL =0600940 =191253 =02328 =03385

20260070 29 046

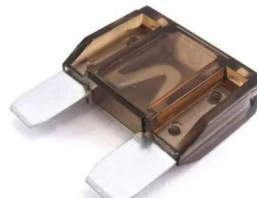

FUSIVEL FICHA MAXI 70A BEGE =0600950 =191254 =FU5070

20260080 29 046



FUSIVEL FICHA MAXI 80A =0600960 =191255 =FU5080 =02329 =03386

20276101 29 046



DIODO 1A MINI PASSAGEM 1A 400V

20281902 29 046



FUSIVEL MINIVAL 2A CINZENTO =192762 =0600210

20281905 29 046



FUSIVEL MINIVAL 5A BRONZE =192765 =0600240

20281910 29 046



FUSIVEL MINIVAL 10A VERMELHO =192767 =0600260

20281915 29 046



FUSIVEL MINIVAL 15A AZUL
=192768 =0600270

20281920 29 046



FUSIVEL MINIVAL 20A AMARELO
=192769 =0600280

20281925 29 046



FUSIVEL MINIVAL 25A BRANCO
=192770 =0600290

20281930 29 046



FUSIVEL MINIVAL 30A VERDE
=192771 =0600302

20290005 29 046



MICRO FUSIVEL 3 LAMINAS 32V 5A
BEGE =193380

20290010 29 046



MICRO FUSIVEL 3 LAMINAS 32V 10A
VERMELHO =193377 =FC310

20290015 29 046



MICRO FUSIVEL 3 LAMINAS 32V 15A
AZUL =193378 =FC315 193382

20290075 29 046



MICROFUSIVEL 3 LAMINAS 32V 7.5A
CASTANHO =193383

20290999 29 046



MICRO FUSIVEL 3 LAMINAS PASSAGEM
SHUNT

20356005 29 046



FUSIVEL ATO 5A
=192936

20356006 29 046



FUSIVEL TESTE REARME 6A VERDE
12/24V 32MAX

20356008 29 046



FUSIVEL ATO 8A

20356010 29 046



FUSIVEL ATO 10A
=192938

20356015 29 046



FUSIVEL ATO 15A
=192939

20356020 29 046



FUSIVEL ATO 20A
=192940

20356025 29 046



FUSIVEL ATO 25A
=192941

20356030 29 046



FUSIVEL TESTE REARME 30A VERDE
12/24V 32max

20450005 29 046



FUSIVEL FICHA 5A =0700310
=0600410 =190055 =FU4005

20450010 29 046



FUSIVEL FICHA 10A VERMELHO
=190057 =01334 =0600430

20450015 29 046



FUSIVEL FICHA 15A
=0600440 =190058 =FU4015 =01335

20450020 29 046



FUSIVEL FICHA 20A AMARELO
=0600450 =190059 =FU4020 =01336

20450025 29 046

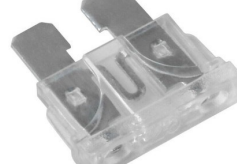

FUSIVEL FICHA 25A CINZA
=0600460 =190060 =FU4025 =01337

20450030 29 046



FUSIVEL FICHA 30A
=0600470 =190061 =FU4030 =01338

20450075 29 046

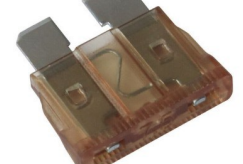

FUSIVEL FICHA 7.5A CASTANHO
=0600420 =01333 =190056

20470002 29 046



FUSIVEL FICHA MICRO 2A CINZENTO
=0600090 =191465

20470003 29 046



FUSIVEL FICHA MICRO 3A PURPURA
=0600100 =191466

20470004 29 046



FUSIVEL FICHA MICRO 4A ROSA
=0600101 =191467

20470005 29 046

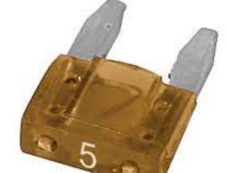

FUSIVEL FICHA MICRO 5A =0600110
=191468 =FU4505 =02217

20470010 29 046



FUSIVEL FICHA MICRO 10A =0600130
=191470 =FU4510 =02219

20470015 29 046



FUSIVEL FICHA MICRO 15A =0600140
AZUL =191471 =FU4515 =02220

20470020 29 046

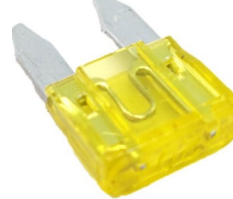

FUSIVEL FICHA MICRO 20A =0600150
=191472 =FU4520 =02221

20470025 29 046

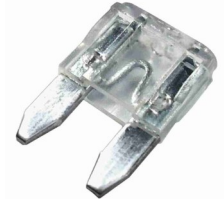

FUSIVEL FICHA MICRO 25A =0600160
=191473 =02222 =FU4525

20470030 29 046



FUSIVEL FICHA MICRO 32V 30A
=191474 =0600170 =02223

20470075 29 046



FUSIVEL FICHA MICRO 7.5A=0600120
=191469 =FU4575 =02218

20500050 29 046



FUSIVEL CF8 50A

20500075 29 046



FUSIVEL CF8 75A

20500100 29 046



FUSIVEL CF8 100A

20500125 29 046



FUSIVEL CF8 125A

20500150 29 046



FUSIVEL CF8 150A

20500175 29 046



FUSIVEL CF8 175A

20500250 29 046



FUSIVEL CF8 250A

20502005 29 046



FUSIVEL TIPO BOSCH 5A
TORPEDO =0200140 =FU2905B

20503008 29 046



FUSIVEL TIPO BOSCH 8A
=0200150 =FU2908B

20503010 29 046



FUSIVEL TIPO BOSCH 10A
TORPEDO =0300152

20503016 29 046



FUSIVEL TIPO BOSCH 16A
=0200170 =FU2916B

20503025 29 046



FUSIVEL TIPO BOSCH 25A
=0300180

20503040 29 046



FUSIVEL TORPEDO 40A

20512001 29 046



FUSIVEL RADIO 1A (und) CURTO
=0530400 =0430400

20512002 29 046



FUSIVEL RADIO 2AMP CURTO
=0530500 =0430500 =FU2602

20512004 29 046



FUSIVEL RADIO 4A CURTO
=0430700

20512005 29 046



FUSIVEL RADIO 5A CURTO
=0430800

20512006 29 046



FUSIVEL RADIO 6A CURTO
20mm

20512008 29 046



FUSIVEL RADIO 8A CURTO
20mm

20512010 29 046



FUSIVEL RADIO 10A CURTO
20mm

20513002 29 046



FUSIVEL RADIO 2A COMPRIDO
=0433200

20513003 29 046



FUSIVEL RADIO 3A COMPRIDO
32mm

20513005 29 046



FUSIVEL RADIO 5A COMPRIDO
=0433400

20513010 29 046



FUSIVEL TIPO LUCAS 10A
0433500

20513015 29 046



FUSIVEL TIPO LUCAS 16A
0433600

20513020 29 046



FUSIVEL TIPO LUCAS 20A
0433700

20513025 29 046



FUSIVEL TIPO LUCAS 25A
=0433800

20513030 29 046



FUSIVEL TIPO LUCAS 30A
=0433850

20513035 29 046



FUSIVEL RADIO 35A COMPRIDO
=0433900

20513075 29 046



FUSIVEL RADIO 7.5A
=0433450

21211002 29 046



PORTA FUSIVEIS P/MIDIVAL PRETO
0100360 =P160 =191190 =03506

21225001 29 046



PORTA FUSIVEIS PIN43560
PARAFUSO 10mm =192344

21250005 29 046



PORTA FUSIVEIS UNIVAL =02337
=0300615 =191640 =0100336

21250011 29 046



PORTA FUSIVEIS TIPO JAPONES
C/FIO =0100350 =P150

21253011 29 046



PORTA FUSIVEIS TIPO JAPONES
0100341

21253012 29 046



PORTA FUSIVEIS TIPO JAPONES 20A
=0300351 =0100351 =191054 =P151

21260002 29 046



PORTA FUSIVEIS MAXI
=0100337 =992510 =02338

21263003 29 046



PORTA FUSIVEIS P/MAXI
=3001001 =191775

21270003 29 046



PORTA FUSIVEIS MINIVAL
IMPERM. =0100335 =02336 =P145

21272001 29 046



ADAPTADOR EXTENSAO FUSIVEL MINI
2x mini =02333

21502001 29 046



PORTA FUSIVEIS TIPO BOSCH 8A
=0300300

JEF540C 29 046



CAIXA FUSIVEL BATERIA 4 FUSES

LB4540M 29 055



LAMPADA BA20d 2P 12V
45/40W 70x35mm

HC1021 29 065



BASE AUTOCOLANTE SUP. BRACADEI-
5.3mm 270x270mm PRETO =191960

PEP120NG 29 065



GARRA BATERIA 120A (und) PRETA
NEG. =4914259 =PZ180N

PEP120RO 29 065



GARRA BATERIA 120A (und) VERM.
POSIT. =4914258 =PZ180R

PEP400NG 29 065



GARRA BATERIA 400A (und) PRETA
NEG. =4914268 =PZ400N

PEP400RO 29 065



GARRA BATERIA 400A (und) VERM.
POSIT. =4914267 =PZ400R

PEP40NG 29 065



GARRA BATERIA 40A (unid) PRETA
NEG. =4914222 =192192 =PZ080N

PEP40RO 29 065



GARRA BATERIA 40A (und) VERMELHA
POSIT. =4914221 =192191 =PZ080R

PEP500NG 29 065



GARRA BATERIA 500A (und) PRETA
NEG. =4914313 =192294

PEP500RO 29 065



GARRA BATERIA 500A (und) VERM.
POSIT. =4914312 =192293

PEP600NG 29 065



GARRA BATERIA 600A PRETA
C/FITA COBRE =4914323

PEP600RO 29 065



GARRA BATERIA 600A VERMELHA
C/FITA COBRE =4914322

SE051 29 065

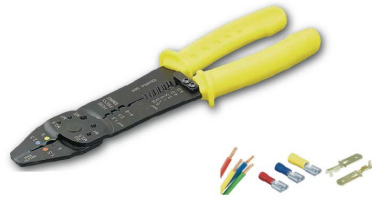

ALICATE P/TERMINAIS ISOLADOS

SE052 29 065



ALICATE P/TERMINAIS NAO ISOLADOS
=9602450 =TF51

RE261 29 071



RELE INTERMITENTE 12V 180W
UNIVERSAL 3PINOS

RE351 29 071



RELE INTERMITENTE 24V 180A
C/METAL

10104 29 081

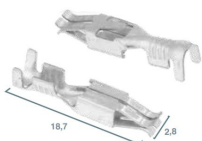

Cable Secc. 1,5-2,5 mm²

TERMINAL FEMEA P/FICHA INJETOR
FICHA 81108 =192155

10105 29 081

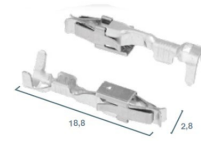

Cable Secc. 0,5-1,0 mm²

TERMINAL FEMEA P/FICHA
9299401 =192175 1107212

10107 29 081



TERMINAL ELECT. MACHO
0,5-1mm

10109 29 081

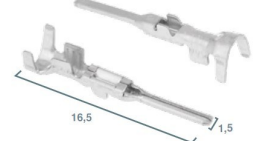

Cable Secc. 1,0-1,5 mm²

TERMINAL MACHO S-SEAL M150
P/FIO =1105550 TS522

10110 29 081

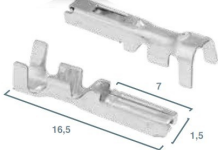

Cable Secc. 1,0-1,5 mm²

TERMINAL FEMEA S-SEAL F150
P/FIO =1105560 =TD532 =192090

10111 29 081

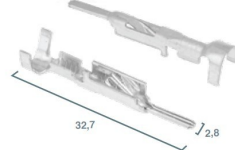

Cable Secc. 1,0-2,5 mm²

TERMINAL MACHO METRIPACK M280
P/FIO =1104500

10112 29 081

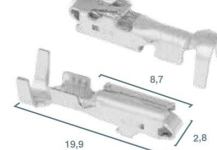

Cable Secc. 1,0-2,5 mm²

TERMINAL FEMEA METRIPACK F280
P/FIO =1104510

10114 29 081

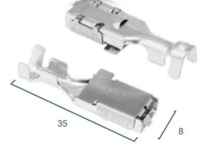

4,0-6,0 mm²

TERMINAL P/PORTA FUSIVEIS C/CLIP
4x6mm ACO INOX =110766

10127 29 081

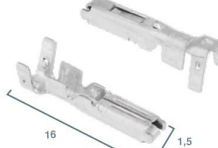

Cable Secc. 0,75-1,5 mm²

TERMINAL FEMEA S-SEAL F150
1,5mm

10128 29 081

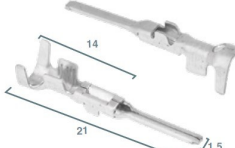

Cable Secc. 0,75-1,5 mm²

TERMINAL MACHO S-SEAL M150
1,5mm

10130 29 081

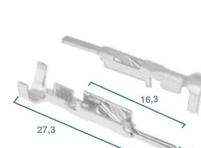

Cable Secc. 0,5-1,0 mm²

TERMINAL MACHO S-SEAL F150

10139 29 081

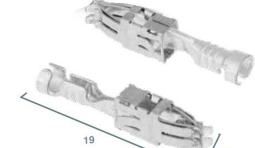

Cable Secc. 0,5-1,0 mm²

TERMINAL FEMEA S-SEAL F280

10145 29 081



TERMINAL FEMEA SICMA2 F280
0.35x0.75

10158 29 081

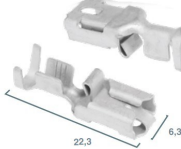

Cable Secc. 0,5-1,5 mm²

TERMINAL FEMEA ANTIF F630

10160 29 081



TERMINAL P/9076 H7

10167 29 081

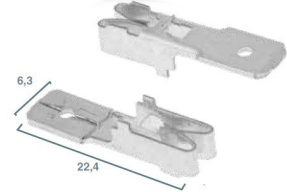

TERMINAL MACHO UNIV. F630

10168 29 081

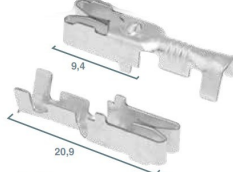

Cable Secc. 0,5-1,5 mm²

TERMINAL FEMEA UNIV. F630

3310 29 081

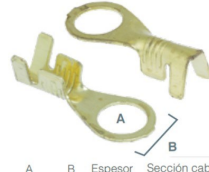

A	B	Espesor	Sección cable
8,4	14,0	0,8	1,00 - 2,50 mm ²

TERMINAL OLHAL FURO 6.4
2.5x4mm

3311 29 081

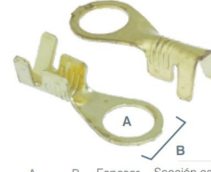

A	B	Espesor	Sección cable
8,4	14,0	0,8	4,00 - 6,00 mm ²

TERMINAL OLHAL
=1603000

3314 29 081

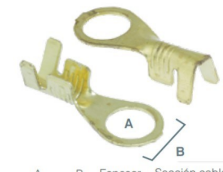

A	B	Espesor	Sección cable
10,5	18,5	0,8	1,50 - 4,00 mm ²

TERMINAL OLHAL (251)
P/FIO 10.5x18 =1602550

3378 29 081



A	B	Espesor	Sección cable
6,2	8,6	0,8	0,75 - 2,00 mm ²

TERMINAL OLHAL
14x26.5mm =1602990 =TD378

3462 29 081



A	B	Espesor	Sección cable
3,6	7,0	0,8	0,50 - 1,50 mm ²

TERMINAL FORQUILHA
0.5x1.5mm

4408 29 081



A	Espesor	Sección cable
2,8	0,5	0,50 - 1,00 mm ²

TERMINAL FEMEA (2921/3)
=1301390 =191083 =TD408

4416 29 081



A	Espesor	Sección cable
4,8	0,5	1,00 - 2,50 mm ²

TERMINAL FEMEA
4.8mm

4422 29 081



A	Espesor	Sección cable
6,3	0,8	1,00 - 2,50 mm ²

TERMINAL FEMEA (292)
1901355916 =1301400 = TD498

4427 29 081



A	Espesor	Sección cable
9,5	1,2	4,00 - 6,00 mm ²

TERMINAL FEMEA
=1301420

4437 29 081



A	Espesor	Sección cable
2,8	0,5	0,50 - 1,00 mm ²

TERMINAL FEMEA C/TRAVAO

4445 29 081



A	Espesor	Sección cable
6,3	0,8	1,00 - 2,50 mm ²

TERMINAL FEMEA LATAO
=1301650 =192376 =190252

4498 29 081



A	Espesor	Sección cable
6,3	0,8	1,00 - 2,50 mm ²

TERMINAL FEMEA
6.3mm

5200 29 081

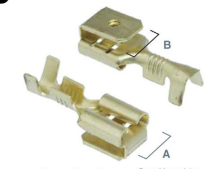

A	B	Espesor	Sección cable
6,3	6,3	0,8	0,75 - 1,50 mm ²

TERMINAL DUPLO
P/FIO =1301501 =TD200

6600 29 081



B	Espesor	Sección cable
6,3	0,8	1,00 - 2,50 mm ²

TERMINAL MACHO (291)
P/FIO 1-2.5mm =1301412

6604 29 081



B	Espesor	Sección cable
6,3	0,8	1,00 - 2,50 mm ²

TERMINAL MACHO (291.1)
P/FIO =1301660 =190270 =TD604

6624 29 081



B	Espesor	Sección cable
4,8	0,5	0,50 - 1,00 mm ²

TERMINAL MACHO 1904478325
=192443 =1301391 =TD412

707 29 081

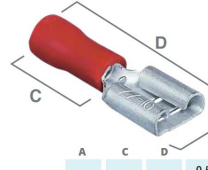

A	C	D	A
4,8	10,0	22,0	0,5

TERMINAL ISOLADO FEMEA
P/FIO =1850300 =RO488

708 29 081

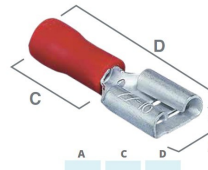

A	C	D	A
2,8	10,0	22,0	0,8

TERMINAL ISOLADO FEMEA 0.8mm
P/FIO =1850400 =RO288

716 29 081

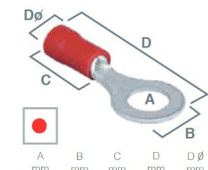

A	B	C	D	D ϕ
3,2	5,5	11,0	16,3	4,0

TERMINAL ISOLADO OLHAL
=1853050 =190038

718 29 081

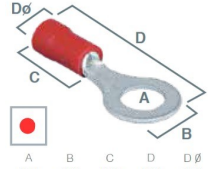

A	B	C	D	D ϕ
4,3	6,6	11,0	17,6	4,0

TERMINAL ISOLADO OLHAL
=1853070 =190027

719 29 081

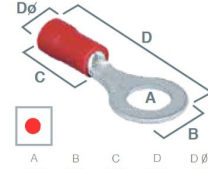

A	B	C	D	D ϕ
5,3	8,0	11,0	18,3	4,0

TERMINAL ISOLADO OLHAL
=1853150 =190031 =RON053

720 29 081

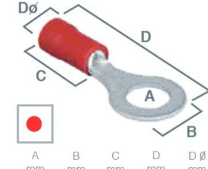

A	B	C	D	D ϕ
6,4	11,6	11,0	22,4	4,0

TERMINAL ISOLADO OLHAL
P/FIO =1853200 =190015 =RON064

721 29 081

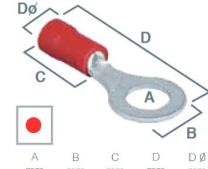

A	B	C	D	D ϕ
8,4	11,6	11,0	22,4	4,0

TERMINAL ISOLADO OLHAL
=1853250 =192352 =RON084

726 29 081

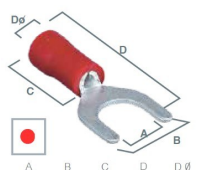

A	B	C	D	D ϕ
4,3	6,4	11,0	21,0	4,0

TERMINAL ISOLADO VERMELHO
0.25x1.65mm

736 29 081

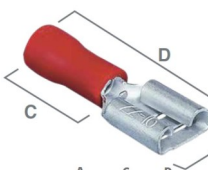

A	C	D	A
6,4	10,0	22,0	0,8

TERMINAL ISOLADO FEMEA VERME-
=190022 =1851000 =RO638

737 29 081

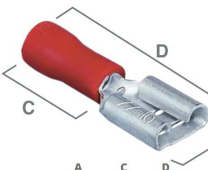

A	C	D	A
4,8	10,0	22,0	0,5

TERMINAL ISOLADO FEMEA
P/FIO =1850500 =RO485

738 29 081

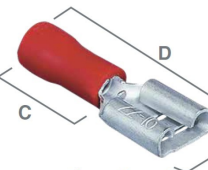

A	C	D	A
2,8	10,0	22,0	0,5

TERMINAL ISOLADO FEMEA VERME-
1901355866 =190049 =1850200

739 29 081

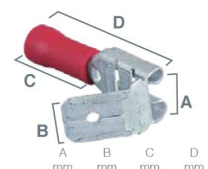

A	B	C	D
6,4	6,4	10,0	22,0

TERMINAL ISOLADO DUPLO
1901360820 =1852500 =RO6382

740 29 081

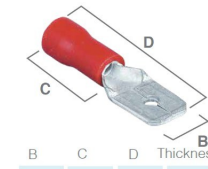

B	C	D	Thickness
6,4	10,0	22,0	0,8

TERMINAL ISOLADO MACHO VERME-
8784480010 =190019 =1852000

747 29 081

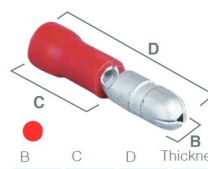

B	C	D	Thickness
4,0	11,0	22,0	0,8

TERMINAL ISOLADO REDONDO
=1864000 =190021 =RO400

7502 29 081



A	B	Espesor	Sección cable
4,0	14,5	0,8	1,00 - 2,50 mm ²

TERMINAL MACHO

752 29 081

A	C	D	Thickness
6,4	7,4	23,7	0,8

**TERMINAL ISOLADO FEMEA VERME-
P/FIO =190985 =1851500 =RO638F**

758 29 081

A	D	Thickness	Sección cable
4,0	22,7	0,8	0,50 - 1,65 mm ²

**TERMINAL TODO ISOLADO VERMELHO
=190028 =1868000 =RO170L**

760 29 081

A	C	D	Thickness
4,0	10,0	24,0	0,8

**TERMINAL ISOLADO FEMEA VERME-
=190017 =1864100 =RO395F**

800 29 081

B	C	D	Thickness
4,8	10,0	22,0	0,5

TERMINAL ISOLADO MACHO

805 29 081

A	C	D	Thickness
2,8	10,0	22,0	0,5

**TERMINAL ISOLADO FEMEA AZUL
P/FIO =192795 =1854200**

807 29 081

A	D	Thickness	Sección cable
4,5	22,7	0,8	1,04 - 2,63 mm ²

**TERMINAL TODO ISOLADO AZUL
=190001 =1868100 =AZ230L**

812 29 081

B	C	D	Thickness	Sección cable
2,0	11,0	22,9	0,8	1,04 - 2,63 mm ²

**TERMINAL ISOLADO PONTA
1x2.5mm**

817 29 081

A	B	C	D	Dφ	Sección cable
4,3	6,6	11,0	17,3	4,5	1,04 - 2,63 mm ²

**TERMINAL ISOLADO OLHAL AZUL
=190029 =1857100 =AZN043**

818 29 081

A	B	C	D	Dφ	Sección cable
5,3	9,5	11,0	18,3	4,5	1,04 - 2,63 mm ²

**TERMINAL ISOLADO OLHAL
=1857150 =190032 =AZN053**

819 29 081

A	B	C	D	Dφ	Sección cable
6,4	12,0	11,0	22,0	4,5	1,04 - 2,63 mm ²

**TERMINAL ISOLADO OLHAL AZUL
=190034 =1857200 =AZN064**

820 29 081

A	B	C	D	Dφ	Sección cable
8,4	12,0	11,0	22,0	4,5	1,04 - 2,63 mm ²

**TERMINAL ISOLADO OLHAL AZUL
P/FIO =1857250 =190039 =AZN084**

824 29 081

A	B	C	D	Dφ	Sección cable
5,3	8,0	11,0	21,0	4,5	1,04 - 2,63 mm ²

**TERMINAL ISOLADO AZUL
1x2.5mm**

825 29 081

A	B	C	D	Dφ	Sección cable
4,3	6,4	11,0	21,0	4,5	1,04 - 2,63 mm ²

**TERMINAL ISOLADO 4.3
1.4-2.63m**

826 29 081

**TERMINAL Y ISOLADO AZUL
3.7x5.7x11x21**

836 29 081

A	B	C	D	Thickness	Sección cable
6,4	10,0	22,0	0,8	1,04 - 2,63 mm ²	

**TERMINAL ISOLADO FEMEA
=1855000 =190020 =AZ638**

837 29 081

A	B	C	D	Thickness	Sección cable
4,8	10,0	22,0	0,5	1,04 - 2,63 mm ²	

**TERMINAL ISOLADO FEMEA
P/FIO 0.25/1.0mm =1854500**

838 29 081

A	B	C	D	Thickness	Sección cable
6,4	6,4	10,0	22,0	0,8	1,04 - 2,63 mm ²

**TERMINAL ISOLADO DUPLO
1901360821 =1862500 =AZ6382**

839 29 081

B	C	D	Thickness	Sección cable
6,4	10,0	22,0	0,8	1,04 - 2,63 mm ²

**TERMINAL ISOLADO MACHO
=190016 =1856000 =AZ635**

845 29 081

B	C	D	Thickness	Sección cable
5,0	11,0	22,0	0,8	1,04 - 2,63 mm ²

**TERMINAL ISOLADO MACHO
=18.64500 =190023**

846 29 081

B	C	D	Thickness	Sección cable
4,0	11,0	22,0	0,8	1,04 - 2,63 mm ²

**TERMINAL ISOLADO REDONDO VERM.
8784480001 =1864300 =AZ400**

850 29 081

A	B	C	D	Thickness	Sección cable
6,4	7,4	23,7	0,8	1,04 - 2,63 mm ²	

**TERMINAL ISOLADO FEMEA AZUL
P/FIO =1855500 =190046 =AZ638F**

8502 29 081

A	B	Espesor	Sección cable
4,0	10,0	0,8	1,00 - 2,50 mm ²

**TERMINAL FEMEA
=1201110**

864 29 081

A	C	D	Thickness	Sección cable
4,0	11,0	25,0	0,8	1,04 - 2,63 mm ²

**TERMINAL ISOLADO FEMEA
8781355800 =1864400**

865 29 081

A	C	D	Thickness	Sección cable
5,0	11,0	25,0	0,8	1,04 - 2,63 mm ²

**TERMINAL ISOLADO FEMEA AZUL
P/FIO =190018 =1864600**

900 29 081

B	C	D	Thickness	Sección cable
5,0	13,7	25,1	0,8	2,63 - 6,64 mm ²

**TERMINAL ISOLADO MACHO AMARELO-
CILIND. =190051 =1864700 =AM500**

901 29 081

**TERMINAL CILINDRO FEMEA AMARELO
5x12x15.5 2.5*6.65mm**

916 29 081

A	B	C	D	Dφ	Sección cable
10,5	15,0	13,7	34,0	6,3	2,63 - 6,64 mm ²

**TERMINAL ISOLADO OLHAL
8781353133 =1863300 =AMN105**

917 29 081

A	B	C	D	Dφ	Sección cable
8,4	15,0	13,7	34,0	6,3	2,63 - 6,64 mm ²

**TERMINAL ISOLADO OLHAL AMARELO
=190255 =1863250 =AMN084**

918 29 081

A mm	B mm	C mm	D mm	D ø mm	Sección cable / Section mm²
6,4	12,0	13,7	33,0	6,3	2,63 - 6,64

TERMINAL ISOLADO OLHAL AMARELO
=190035 =1863200 =AMN064

919 29 081

A mm	B mm	C mm	D mm	D ø mm	Sección cable / Section mm²
5,3	9,5	13,7	26,3	6,3	2,63 - 6,64

TERMINAL ISOLADO OLHAL
P/FIO =1863150 =AMN053

920 29 081

A mm	B mm	C mm	D mm	D ø mm	Sección cable / Section mm²
4,3	9,5	13,7	26,3	6,3	2,63 - 6,64

TERMINAL ISOLADO OLHAL
4.3 - 2.63/6.64mm =1863100

930 29 081

A mm	B mm	C mm	D mm	Thickness mm	Sección cable / Section mm²
9,5	14,0	24,0	0,8	2,63 - 6,64	

TERMINAL ISOLADO FEMEA AMARELO
P/FIO =190048 =1863000 =AM950C

931 29 081

A mm	B mm	C mm	D mm	Thickness mm	Sección cable / Section mm²
6,4	14,0	24,0	0,8	2,63 - 6,64	

TERMINAL ISOLADO FEMEA AMARELO
=1861000 =190024 =AM638

932 29 081

B mm	C mm	D mm	Thickness mm	Sección cable / Section mm²
6,4	14,0	24,0	0,8	2,63 - 6,64

TERMINAL ISOLADO MACHO AMARELO
=1862000 =191191 =AM635

935 29 081

A mm	D mm	Thickness mm	Sección cable / Section mm²
6,8	26,7	0,8	2,63 - 6,64 mm²

TERMINAL TODO ISOLADO AMARELO
2.5x6mm =190030 =1868200

CR100 29 081

A mm	B mm	D mm	Sección cable / Section mm²
9,5	13,0	20,0	0,25 - 1,65 mm²

TERMINAL LIGADOR (ladr.) ISOLADO VERMELHO
=4410090 =RO100 191076

CR250 29 081

A mm	B mm	D mm	Sección cable / Section mm²
9,5	13,0	20,0	1,04 - 2,63mm²

TERMINAL LIGADOR (ladr.) ISOLADO
=4410091 =190971 =02341 =AZ250

CR255 29 081

A mm	B mm	C mm	Sección cable / Section mm²
6,4	9,5	38	1,00 - 2,50 mm²

TERMINAL LIGADOR (ladr.) ISOLADO
1x2.5mm

CR600 29 081

A mm	B mm	D mm	Sección cable / Section mm²
12,0	16,0	21,0	2,63 - 6,64 mm²

TERMINAL LIGADOR (ladr.) ISOLADO AMARELO
=4410092 =02342

CT2002NAT 29 081

ISOLADOR TERMINAL P/FEMEA
=4410077 =191007

ES6604 29 081

B mm	Espesor mm	Sección cable / Section mm²
6,3	0,8	1,00 - 2,50 mm²

TERMINAL MACHO
P/FIO =190270 =TD604 =1301660

ES758 29 081

4,4	Sección cable / Section mm²
0,5 - 1,5 mm²	

TERMINAL ISOL. RETRATIL VERM.
P/EMENDA FIO =1880230 =RO370

ES770 29 081

4,2	37,0	Sección cable / Section mm²
0,50 - 1,00 mm²		

CONECTOR ISOLANTE 4.2mm VERM.
=191701

ES807 29 081

5,6	Sección cable / Section mm²
1,5 - 2,5 mm²	

TERMINAL ISOLADO RETRATIL AZUL
P/EMENDA =1880240 =AZ370

ES870 29 081

4,7	37,0	Sección cable / Section mm²
1,00 - 2,50 mm²		

CONECTOR ISOLANTE 4.7mm AZUL
=191702

ES935 29 081

6,4	Sección cable / Section mm²
4 - 6 mm²	

TERMINAL ISOLADO RETRATIL AMARELO
=18.80250

ES970 29 081

7,1	42,0	Sección cable / Section mm²
4,00 - 6,00 mm²		

CONECTOR ISOLANTE 7.1mm

PH1010 29 081

ISOLADOR TERMINAL MTA P/TERMINAL FEMEA
=4410068

PH1020NAT 29 081

ISOLADOR TERMINAL P/FEMEA
=4410076

PH1021NG 29 081

ISOLADOR TERMINAL P/FEMEA
=4410070 =FH201

PH1026RO 29 081

ISOLADOR TERMINAL P/FEMEA
=4410074 =FH206

TB001 29 081

TERMINAL BATERIA NORMAL POSITIVO TIPO BOSCH - 49P = POSITIVOS

TB004 29 081

TERMINAL BATERIA NORMAL NEGATIVO TIPO BOSCH - 49N = NEGATIVOS
☎253607320

TB02710 29 081

TERMINAL BATERIA POSITIVO M10
=192402 =1506120
✉geral@vieirafreitas.pt

TB0278 29 081

TERMINAL BATERIA POSITIVO M8
=192402 =1506120
🌐vieirafreitas.pt

TB02810 29 081

TERMINAL BATERIA NEGATIVO M10
=192403 =1506130

TB063 29 081



TERMINAL BATERIA C/CORTE VERDE =192493 =3RG81083=M82539

TB086 29 081



TERMINAL BATERIA NEGATIVO 25x40mm =150666

22150002 29 082



Pos.	12V	24V
83	10A	5A
75	20A	10A
15	25A	13A
50	50A	25A

INTERRUPTOR IGNICAO S/AQUEC. =ISC7 =230105 =327300 =180027

22150003 29 082



Pos.	12V	24V
2	24A	12A
3	20A	10A
4	24A	12A

INTERRUPTOR IGNICAO C/AQUEC.